



**BOARD OF COUNTY COMMISSIONERS
WARREN COUNTY, OHIO**

406 Justice Drive, Lebanon, Ohio 45036

www.co.warren.oh.us

commissioners@co.warren.oh.us

Telephone (513) 695-1250

Facsimile (513) 695-2054

**TOM GROSSMANN
SHANNON JONES
DAVID G. YOUNG**

21-0851

June 22, 2021

**AUTHORIZE THE PRESIDENT OF THE BOARD TO ENTER INTO CONTRACT WITH
BARRETT PAVING MATERIALS, INC. FOR THE FY20 SOUTH LEBANON / UNION
TOWNSHIP – LEBANON ROAD IMPROVEMENT CDBG PROJECT**

WHEREAS, pursuant to Resolution #21-0768, adopted June 08, 2021, this Board approved a Notice of Intent to Award Contract for the FY20 South Lebanon / Union Township – Lebanon Road Improvement CDBG Project to Barrett Paving Materials Inc., 3751 Commerce Drive Franklin, Ohio, for a total contract price of \$224,602.25.; and

WHEREAS, all documentation including, performance bonds, insurance certificates, etc., has been submitted by the contractor; and

NOW THEREFORE BE IT RESOLVED, to enter into contract with Barrett Paving Materials, Inc., for said project, for a total contract price of \$224,602.25; as attached hereto and made a part hereof.

Mrs. Jones moved for adoption of the foregoing resolution being seconded by Mr. Young. Upon call of the roll, the following vote resulted:

Mr. Grossmann – yea

Mr. Young – yea

Mrs. Jones – yea

Resolution adopted this 22nd day of June 2021.

BOARD OF COUNTY COMMISSIONERS

Tina Osborne, Clerk

KP\

cc: c/a—Barret Paving Materials Inc.
OGA (file)
OMB Bid file



BOARD OF COUNTY COMMISSIONERS
WARREN COUNTY, OHIO
406 Justice Drive, Lebanon, Ohio 45036
www.co.warren.oh.us
commissioners@co.warren.oh.us

Telephone (513) 695-1250
Facsimile (513) 695-2054

TOM GROSSMANN
SHANNON JONES
DAVID G. YOUNG

21-0768

June 08, 2021

APPROVE NOTICE OF INTENT TO AWARD BID TO BARRETT PAVING MATERIALS, INC. FOR THE FY2020 SOUTH LEBANON / UNION TOWNSHIP – LEBANON ROAD IMPROVEMENT CDBG PROJECT

WHEREAS, bids were closed at 9:30 a.m., June 1, 2021, and the bids received were opened and read aloud for the FY2020 South Lebanon / Union Township – Lebanon Road Improvement CDBG Project and the results are on file in the Commissioners' Office; and

WHEREAS, upon review of such bids by Susanne Mason, Project Manager, Warren County Office of Grants Administration, Barret Paving Materials, Inc., has been determined to be the lowest and best bidder; and

NOW THEREFORE BE IT RESOLVED, upon recommendation of the Warren County Office of Grants Administration, that it is the intent of this Board to award the bid to Barrett Paving Materials, 3751 Commerce Drive Franklin, Ohio 45005, for a total bid price of \$224,602.25; and

BE IT FURTHER RESOLVED, that the President of the Board is hereby authorized to execute a "Notice of Intent to Award."

Mrs. Jones moved for adoption of the foregoing resolution being seconded by Mr. Grossmann. Upon call of the roll, the following vote resulted:

Mr. Young – yea
Mr. Grossmann – yea
Mrs. Jones – yea

Resolution adopted this 8th day of June 2021.

BOARD OF COUNTY COMMISSIONERS

Tina Osborne, Clerk

KP\

cc: OGA (file)
OMB Bid file



**BOARD OF COUNTY COMMISSIONERS
WARREN COUNTY, OHIO**

406 Justice Drive, Lebanon, Ohio 45036

www.co.warren.oh.us

commissioners@co.warren.oh.us

Telephone (513) 695-1250

Facsimile (513) 695-2054

***TOM GROSSMANN
SHANNON JONES
DAVID G. YOUNG***

BID OPENING

June 1, 2021

BID OPENING –

Bids were closed at 9:30 a.m. this 1st day of June and the following bids were received, opened, and read aloud for the FY2020 South Lebanon / Union Township- Lebanon Road Improvement CDBG Project for Warren County Office of Grants Administration.

Belgray, Inc. Wilmington, Ohio	\$243,632.00
Rack and Ballauer Excavating Co., Inc. Hamilton, Ohio	\$225,988.75
Barrett Paving Materials Franklin, Ohio	\$224,602.25
Adleta Construction Cincinnati, Ohio	\$260,255.63
W. G. Stang LLC Hamilton, Ohio	\$228,700.00

Susanne Mason, Project Manager, Warren County Office of Grants Administration will review bids for a recommendation at a later date.

cc: Bid File

OMB

OGA (file)

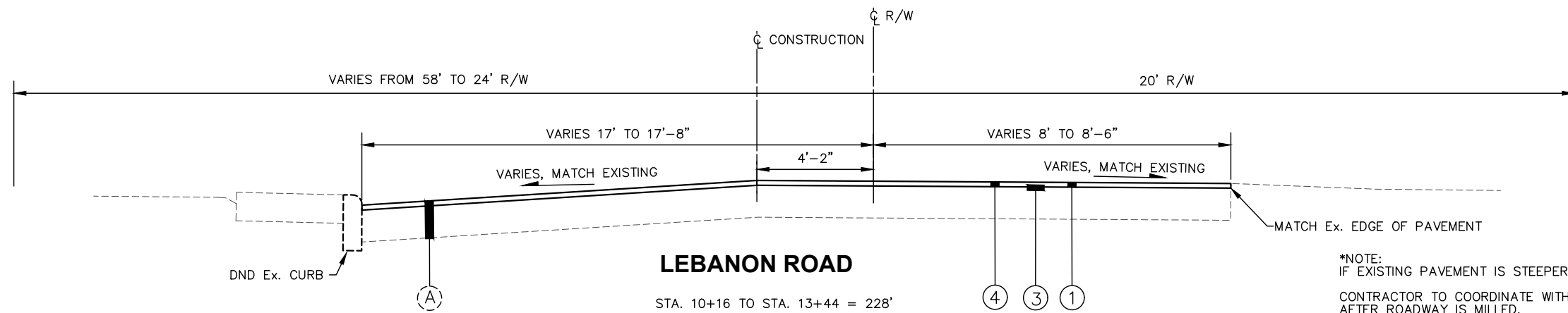

*NOTE:
IF EXISTING PAVEMENT IS STEEPER, MATCH EXISTING SLOPES
CONTRACTOR TO COORDINATE WITH THE VILLAGE ON LOCATIONS OF FULL DEPTH REPAIR
AFTER ROADWAY IS MILLED.

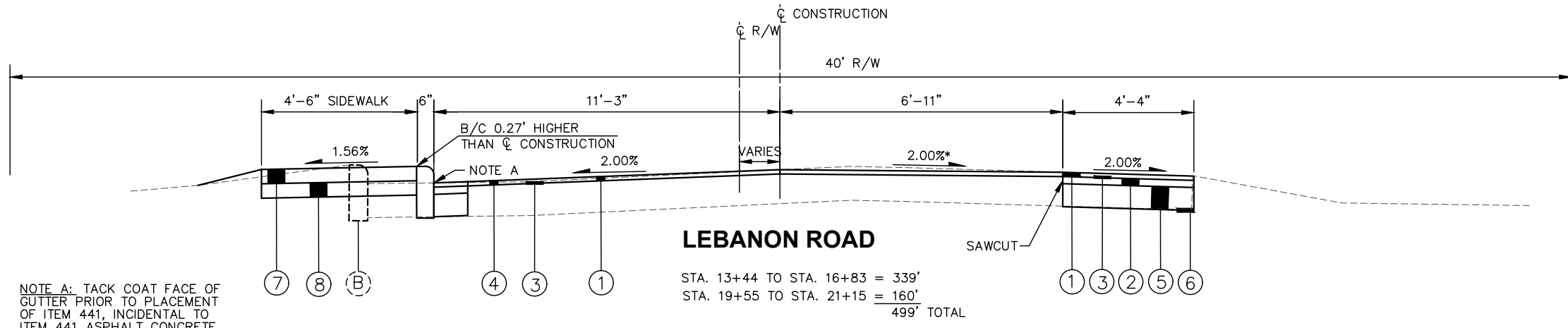

NOTE A: TACK COAT FACE OF GUTTER PRIOR TO PLACEMENT OF ITEM 441, INCIDENTAL TO ITEM 441 ASPHALT CONCRETE.

DEPRESSED CURB FOR DRIVEWAYS, TRANSITION 5' ON EITHER SIDE SO THAT 1.56% MAX SIDEWALK SLOPE IS MAINTAINED

STA. 13+82.17 TO STA. 14+58.03
STA. 14+83.04 TO STA. 15+23.39
STA. 15+36.62 TO STA. 15+49.53
STA. 16+12.94 TO STA. 16+54.68
STA. 16+80.46 TO STA. 16+94.52
STA. 17+42.90 TO STA. 17+56.66
STA. 18+55.39 TO STA. 19+35.09
STA. 20+40.66 TO STA. 20+53.78
STA. 20+98.54 TO STA. 21+11.85
STA. 22+16.89 TO STA. 23+18.79

ABBR./SYMBOL LEGEND

- MH ADJUSTED TO GRADE (ATG)
- CB RECONSTRUCTED TO GRADE (RTG)
- VALVE ADJUSTED TO GRADE
- (DND) DO NOT DISTURB
- (TBR) TO BE REMOVED
- TREE REMOVED

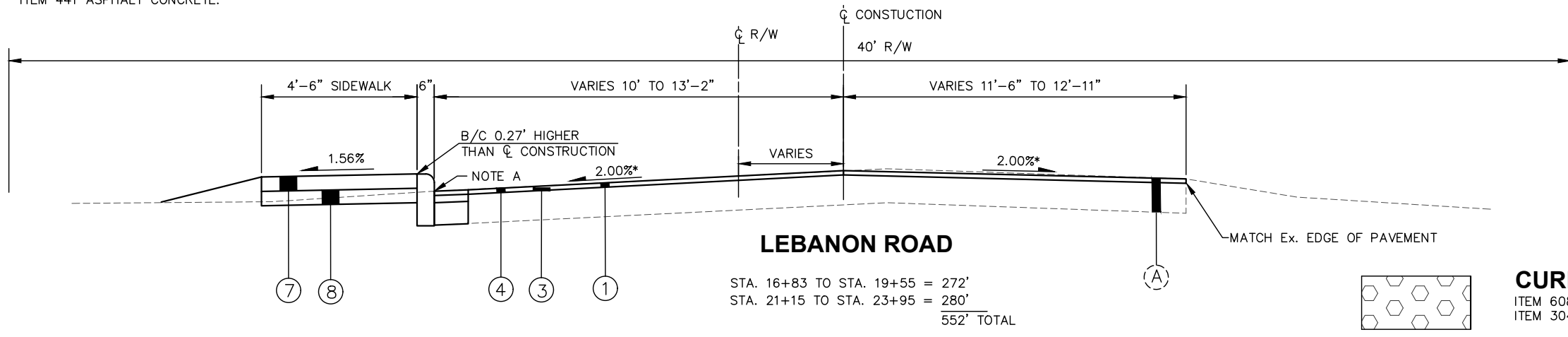

TYPICAL SECTION LEGEND

- ① ITEM 441, 1 1/2" ASPHALT CONCRETE SURFACE COURSE, TYPE 1, (448) PG 64-22 VARIABLE DEPTH IN MILLING AREAS SINCE NEW ROADWAY CROWN IS BEING SHIFTED
- ② ITEM 441, 1 3/4" ASPHALT CONCRETE INTERMEDIATE COURSE, TYPE 1, (448),
- ③ ITEM 407, NON-TRACKING TACK COAT (APPLIED @ 0.09 GAL/S.Y.)
- ④ ITEM 254, 1 1/2" PAVEMENT PLANING, ASPHALT CONCRETE
- ⑤ ITEM 301, 9" ASPHALT CONCRETE BASE, PG64-22 (IN 2 EQUAL LIFTS)
- ⑥ ITEM 204, SUBGRADE COMPACTION
- ⑦ ITEM 608, 4" CONCRETE WALK, AS PER PLAN
- ⑧ ITEM 304, 4" AGGREGATE BASE
- (A) EXISTING ASPHALT AND BASE (THICKNESS UNKNOWN)
- (B) EXISTING CURB (REMOVE)

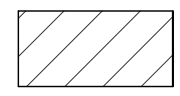

RESIDENTIAL ASPHALT DRIVES

ITEM 441 - 2" ASPHALT CONCRETE SURFACE COURSE, TYPE 1, (448) PG 64-22
ITEM 301 - 4" ASPHALT CONCRETE BASE, PG 64-22

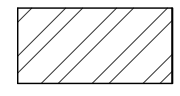

RESIDENTIAL CONCRETE DRIVES

ITEM 452 - 6" NON-REINFORCED CONCRETE PAVEMENT, AS PER PLAN
ITEM 304 - 4" AGGREGATE BASE



CONCRETE WALK

ITEM 608 - 4" CONCRETE WALK, AS PER PLAN
ITEM 304 - 4" AGGREGATE BASE

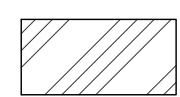

RESIDENTIAL GRAVEL DRIVES

ITEM 304 - 12" AGGREGATE BASE, AS PER PLAN

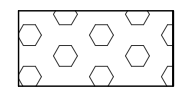

CURB RAMPS

ITEM 608 - CURB RAMP
ITEM 304 - 4" AGGREGATE BASE

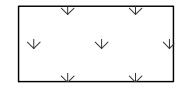

PAVEMENT TO GRASS

ITEM 202 - PAVEMENT REMOVED (INCIDENTAL TO EXCAVATION)
ITEM 659 - SEEDING AND MULCHING, CLASS 1, AS PER PLAN

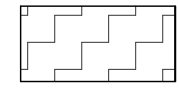

FULL DEPTH PAVEMENT REPAIR

ITEM 441 - 1 1/2" ASPHALT CONCRETE SURFACE COURSE, TYPE 1, (448) PG 64-22
ITEM 407 - NON-TRACKING TACK COAT (APPLIED @ 0.06 GAL/S.Y.)
ITEM 441 - 1 3/4" ASPHALT CONCRETE INTERMEDIATE COURSE, TYPE 1, (448) PG 64-22
ITEM 301 - 9" ASPHALT CONCRETE BASE, PG64-22 (2 EQUAL LIFTS OF 4")
ITEM 204 - SUBGRADE COMPACTION

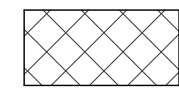

PAVEMENT PLANING AND OVERLAY

FOLLOW TYPICAL SECTION

REVISIONS:

FILE NAME	GYA
DRAWN BY	JET
CHECKED BY	NNS
PROJECT No.	WARSLE2003
DATE	05-3-2021
SHEET NUMBER	2 OF 18

ELEVATION DATUM

ALL ELEVATIONS ARE BASED ON NAVD 88 (CORS 2011 ADJUSTMENT).

GENERAL NOTES AND DETAILS

ALL CONSTRUCTION METHODS, MATERIALS, AND SPECIFICATIONS SHALL COMPLY WITH THE VILLAGE OF SOUTH LEBANON STANDARDS AND SPECIFICATIONS OR OHIO DEPARTMENT OF TRANSPORTATION CONSTRUCTION STANDARDS AND SPECIFICATIONS, WHICHEVER IS MORE RESTRICTIVE AS DETERMINED BY THE VILLAGE.

MODIFICATIONS

ANY MODIFICATIONS TO THE SPECIFICATIONS OR CHANGES TO THE WORK AS SHOWN ON THE DRAWINGS MUST HAVE PRIOR WRITTEN APPROVAL BY THE VILLAGE.

FUNDING

DUE TO FUNDING, THE OWNER RESERVES THE RIGHT TO INCREASE, DECREASE, OR OMIT ANY ITEMS LISTED IN THE BID SCHEDULE.

NO FINAL UNIT PRICE ADJUSTMENTS PER ODOT 104.02 WILL BE MADE AT CONTRACT FINALIZATION.

MISCELLANEOUS

COMPENSATION FOR THE WORK AS SHOWN ON THE PLANS SHALL BE AT THE UNIT PRICES INCLUDED ON THE BID PROPOSAL. NO SEPARATE PAYMENT WILL BE MADE FOR TASKS (NOT ALL INCLUSIVE) INCLUDING ITEMS SUCH AS MOBILIZATION, RECORD DRAWINGS AND CONNECTIONS TO EXISTING FACILITIES.

CONTRACTOR IS RESPONSIBLE TO FILL OUT ALL NECESSARY CO–PERMITTEE PERMITS FOR THE OEPA STORMWATER NOI.

UNDERGROUND UTILITIES

THE LOCATIONS OF THE UNDERGROUND UTILITIES SHOWN ON THE PLANS ARE AS OBTAINED FROM THE OWNERS OF THE UTILITY AS REQUIRED BY SECTION 153.64 ORC. EXISTING UTILITIES ARE SHOWN IN THEIR APPROXIMATE LOCATION ACCORDING TO THE BEST AVAILABLE DATA. THE CONTRACTOR WILL BE RESPONSIBLE FOR LOCATING THEM IN THE FIELD PRIOR TO CONSTRUCTION AND WILL BE RESPONSIBLE FOR ANY DAMAGE DONE TO THEM. CONTRACTOR TO CONTACT OHIO UTILITIES PROTECTION SERVICE (1–800–362–2764) 48 HOURS PRIOR TO CONSTRUCTION.

NON–MEMBERS MUST BE CALLED DIRECTLY.

UTILITY STATEMENT

THE UNDERGROUND UTILITIES SHOWN HAVE BEEN LOCATED FROM FIELD SURVEY INFORMATION AND EXISTING DRAWINGS. CHOICE ONE ENGINEERING CORPORATION MAKES NO GUARANTEES THAT THE UNDERGROUND UTILITIES SHOWN COMPRISE ALL SUCH UTILITIES IN THE AREA, EITHER IN–SERVICE OR ABANDONED. FURTHER, CHOICE ONE ENGINEERING CORPORATION DOES NOT WARRANT THAT THE UNDERGROUND UTILITIES SHOWN ARE IN THE EXACT LOCATION INDICATED, ALTHOUGH CHOICE ONE ENGINEERING CORPORATION DID LOCATE AS ACCURATELY AS POSSIBLE FROM INFORMATION AVAILABLE. CHOICE ONE ENGINEERING CORPORATION HAS NOT PHYSICALLY LOCATED THE UNDERGROUND UTILITIES.

UTILITY OWNERSHIP

ELECTRIC

DUKE ENERGY
2010 DANA AVENUE
ROOM EF 324
CINCINNATI, OH 45207
ATTN: TROY DITTMER
513–458–3844

TELEPHONE

CINCINNATI BELL
221 E. 4TH STREET
BUILDING 121–900
CINCINNATI OH, 45201
ATTN: BRECK COWAN
513–565–7187

TELEPHONE

CENTURY LINK
20 N. MECHANIC STREET
LEBANON OH, 45036
ATTN: JORDAN LANGSTON
513–933–3502

GAS

DUKE ENERGY
139 E. FOURTH STREET
P.O. BOX 96, RM 460–A
CINCINNATI OH, 45202
OH/KYHOUSEBILL@DUKE–ENERGY.COM

CABLE

CHARTER COMMUNICATION
11252 CORNELL PARK DRIVE
CINCINNATI, OH 45242
ATTN: JIM O'REILLY
513–386–5483

WATER, SANITARY AND STORM

VILLAGE OF SOUTH LEBANON
10 N. HIGH ST
SOUTH LEBANON OH, 45065
ATTN: JEFFREY BOYLAN
513–678–3609

WARREN COUNTY WATER AND SEWER

406 JUSTICE DRIVE
LEBANON, OH 45036
ATTN: CHRIS WOJNICZ
513–695–1646

OHIO UTILITY PROTECTION

SERVICE (OUPS)
CONTACT 48 HOURS
"CALL BEFORE YOU DIG"
1–800–362–2764

UTILITY INTERFERENCE

IF, DURING CONSTRUCTION, INTERFERENCE ARISES WITH EXISTING UTILITIES, IT SHALL BE THE RESPONSIBILITY OF THE CONTRACTOR TO NOTIFY THE UTILITY COMPANY INVOLVED. ANY AND ALL WORK REQUIRED FOR PUBLIC OR PRIVATE UTILITIES WILL BE DONE BY AND AT THE EXPENSE OF THEIR RESPECTIVE OWNERS, UNLESS OTHERWISE NOTED ON THESE PLANS. THE CONTRACTOR SHALL NOTIFY, AT LEAST 7 DAYS BEFORE BREAKING GROUND, ALL PUBLIC SERVICE COMPANIES HAVING WIRES, POLES, PIPES, CONDUITS, MANHOLES, OR OTHER STRUCTURES THAT MAY BE AFFECTED BY THIS OPERATION, INCLUDING ALL STRUCTURES WHICH ARE AFFECTED AND NOT SHOWN ON THESE PLANS. THERE WILL BE NO DELAYS ALLOWED FOR UTILITY INTERFERENCES.

LOCATION, SUPPORT, PROTECTION, AND RESTORATION OF ALL UTILITIES, AND STRUCTURES SHALL BE THE RESPONSIBILITY OF THE CONTRACTOR. THE METHOD OF SUPPORT OR PROTECTION MUST BE APPROVED BY THE APPROPRIATE UTILITY COMPANY, AND IF FACILITY IS DAMAGED BY THE CONTRACTOR, ALL REPAIRS SHALL BE MADE BY THE CONTRACTOR AT THE CONTRACTOR'S EXPENSE.

THE CONTRACTOR IS HEREBY ADVISED THAT ALL UTILITY COMPANIES AFFECTED BY THIS PROJECT MAY BE WORKING CONCURRENTLY WITHIN THE PROJECT LIMITS. NO ADDITIONAL COMPENSATION WILL BE MADE TO THE CONTRACTOR FOR COORDINATION. THE CONTRACTOR SHALL BE RESPONSIBLE FOR COORDINATION WITH THE UTILITY COMPANIES.

REVIEW OF DRAINAGE FACILITIES

BEFORE ANY WORK IS STARTED ON THE PROJECT AND BEFORE FINAL ACCEPTANCE BY THE VILLAGE, REPRESENTATIVES OF THE VILLAGE AND THE CONTRACTOR SHALL MAKE AN INSPECTION OF ALL EXISTING SEWER THAT MAY BE AFFECTED BY THE WORK AND ARE TO REMAIN IN SERVICE. THE CONDITION OF THE EXISTING CONDUITS AND THEIR APPURTENANCES SHALL BE DETERMINED FROM FIELD OBSERVATIONS. RECORDS OF THE INSPECTION SHALL BE KEPT IN WRITING BY THE VILLAGE.

ALL NEW CONDUITS, INLETS, CATCH BASINS, AND MANHOLES CONSTRUCTED AS A PART OF THE PROJECT SHALL BE FREE OF ALL FOREIGN MATTER AND IN A CLEAN CONDITION BEFORE THE PROJECT WILL BE ACCEPTED BY THE VILLAGE.

ALL EXISTING SEWERS INSPECTED INITIALLY BY THE ABOVE–MENTIONED PARTIES SHALL BE MAINTAINED AND LEFT IN A CONDITION REASONABLY COMPARABLE TO THAT DETERMINED BY THE ORIGINAL INSPECTION. ANY CHANGE IN THE CONDITION RESULTING FROM THE CONTRACTOR'S OPERATIONS SHALL BE CORRECTED BY THE CONTRACTOR TO THE SATISFACTION OF THE VILLAGE.

PAYMENT FOR ALL OPERATIONS DESCRIBED ABOVE SHALL BE INCLUDED IN THE CONTRACT PRICE FOR THE PERTINENT 611 CONDUIT ITEMS.

EXISTING DRAINAGE FACILITIES

ANY DRAINAGE CONDUIT CURRENTLY CONNECTED TO THE EXISTING STORM SEWER SHALL BE CONNECTED TO THE PROPOSED STORM SEWER. ANY DRAINAGE CONDUIT DAMAGED BY THE CONTRACTOR SHALL BE REPLACED BY THE CONTRACTOR TO A CONDITION EQUAL TO OR BETTER THAN ITS ORIGINAL CONDITION. ALL CONDUIT REMOVED, REPLACED AND/OR CONNECTED TO THE STORM SEWER SHALL BE NOTED ON THE RECORD DRAWINGS AND SHALL BE INSPECTED BY THE CITY BEFORE IT IS COVERED.

A CONCRETE COLLAR SHALL BE PROVIDED WHERE PROPOSED STORM SEWER PIPE IS CONNECTED TO AN EXISTING PIPE. THE COST SHALL BE INCLUDED IN THE BID PRICE FOR THE NEW CONDUIT.

ALL FIELD OR STORM DRAINS WHICH ARE ENCOUNTERED DURING CONSTRUCTION SHALL BE PROVIDED WITH UNOBSTRUCTED OUTLETS OR PLUGGED AS APPROVED AND DIRECTED BY THE VILLAGE. THE VILLAGE WILL ASSIST IN ANY NECESSARY INVESTIGATION OR DYE TESTING PRIOR TO APPROVING THE PLUGGING OF A FIELD OR STORM CONDUIT. COST OF THE ITEMS ABOVE SHALL BE INCLUDED IN THE COST OF ITEM 611 CONDUIT, TYPE B, 707.45, STORM REPAIR.

THE LOCATION, TYPE, SIZE, AND GRADE OF THE NEW CONDUIT REQUIRED TO REPLACE OR EXTEND THE EXISTING DRAIN WILL BE DETERMINED BY THE VILLAGE OR VILLAGE'S REPRESENTATIVE DURING CONSTRUCTION, AND PAYMENT SHALL BE MADE ON FINAL MEASUREMENTS AND INCLUDE ALL MATERIALS NECESSARY SUCH AS GRANULAR BEDDING, PROPER FITTINGS AND CONNECTIONS, AND PIPE.

THE FOLLOWING CONTINGENT ESTIMATED QUANTITIES HAVE BEEN INCLUDED IN THE PLANS FOR THE WORK NOTED ABOVE:

ITEM 611	4"	CONDUIT, TYPE B, 707.45, STORM REPAIR	10 FEET
ITEM 611	6"	CONDUIT, TYPE B, 707.45, STORM REPAIR	10 FEET
ITEM 611	8"	CONDUIT, TYPE B, 707.45, STORM REPAIR	10 FEET

CROSSINGS AND CONNECTIONS TO EXISTING PIPES AND UTILITIES

WHERE PLANS PROVIDE FOR A PROPOSED CONDUIT TO BE CONNECTED TO, OR CROSS OVER OR UNDER AN EXISTING SEWER OR UNDERGROUND UTILITY, THE CONTRACTOR SHALL LOCATE THE EXISTING PIPES OR UTILITIES BOTH AS TO LINE AND GRADE BEFORE STARTING TO LAY THE PROPOSED CONDUIT.

IF IT IS DETERMINED THAT THE ELEVATION OF THE EXISTING CONDUIT, OR EXISTING APPURTENANCE TO BE CONNECTED, DIFFERS FROM THE PLAN ELEVATION, OR RESULTS IN A CHANGE IN THE PLAN CONDUIT SLOPE, THE VILLAGE SHALL BE NOTIFIED BEFORE STARTING CONSTRUCTION OF ANY PORTION OF THE PROPOSED CONDUIT WHICH WILL BE AFFECTED BY THE VARIANCE IN THE EXISTING ELEVATIONS.

IF IT IS DETERMINED THAT THE PROPOSED CONDUIT WILL INTERSECT ANY EXISTING SEWER OR UNDERGROUND UTILITY IF CONSTRUCTED AS SHOWN ON THE PLAN, THE VILLAGE SHALL BE NOTIFIED BEFORE STARTING CONSTRUCTION OF ANY PORTION OF THE PROPOSED CONDUIT WHICH WOULD BE AFFECTED BY THE INTERFERENCE WITH AN EXISTING FACILITY.

PAYMENT FOR ALL THE OPERATIONS DESCRIBED ABOVE SHALL BE INCLUDED IN THE CONTRACT PRICE FOR THE PERTINENT 611 CONDUIT ITEM.

SAFETY

THE CONTRACTOR SHALL BE SOLELY RESPONSIBLE FOR COMPLYING WITH ALL FEDERAL, STATE, AND LOCAL SAFETY REQUIREMENTS, TOGETHER WITH EXERCISING PRECAUTIONS AT ALL TIMES FOR THE PROTECTION OF PERSONS (INCLUDING EMPLOYEES) AND PROPERTY. IT IS ALSO THE SOLE RESPONSIBILITY OF THE CONTRACTOR TO INITIATE, MAINTAIN, AND SUPERVISE ALL SAFETY REQUIREMENTS, PRECAUTIONS, AND PROGRAMS IN CONNECTION WITH THE WORK.

MUD

THE TRACKING OR SPILLING OF MUD, DIRT, OR DEBRIS UPON VILLAGE STREETS IS PROHIBITED, AND ANY SUCH OCCURRENCE SHALL BE CLEANED UP IMMEDIATELY BY THE CONTRACTOR.

PROPERTY POINTS AND SURVEY MONUMENTS

CARE SHALL BE TAKEN BY THE CONTRACTOR TO SAFEGUARD ANY PROPERTY POINTS OR OTHER SURVEY REFERENCE MARKS ENCOUNTERED DURING CONSTRUCTION OF THIS PROJECT. IT SHALL BE THE RESPONSIBILITY OF THE CONTRACTOR TO RESET ANY PROPERTY POINT OR SURVEY MONUMENT WHICH IS DISTURBED AS A RESULT OF CONSTRUCTION OF THIS PROJECT. THE PROPERTY POINTS AND SURVEY MONUMENTS SHALL BE RESET UNDER THE SUPERVISION OF A REGISTERED PROFESSIONAL SURVEYOR.

PAYMENT FOR THIS ITEM SHALL BE INCIDENTAL TO THE OTHER ITEMS PAID FOR IN THIS PROJECT.

NONRUBBER TIRE VEHICLES

NO NONRUBBER TIRE VEHICLES SHALL BE MOVED ON VILLAGE STREETS. EXCEPTIONS MAY BE GRANTED BY THE VILLAGE WHERE SHORT DISTANCES AND SPECIAL CIRCUMSTANCES ARE INVOLVED. GRANTING OF EXCEPTIONS MUST BE IN WRITING AND ANY RESULTING DAMAGE MUST BE REPAIRED TO THE SATISFACTION OF THE VILLAGE. THE CONTRACTOR SHALL USE EXTREME CARE WHEN OPERATING NONRUBBER TIRE VEHICLES ON STREETS OR DRIVEWAYS TO AVOID MARKING OR DAMAGING THE PAVEMENT. PROTECTION OF THE PAVEMENT FROM DAMAGE RESULTING FROM THE TRACKS OF NONRUBBER TIRE VEHICLES UTILIZED IN TRENCH EXCAVATION SHALL BE REQUIRED. A WOOD PLANK SYSTEM, USED TIRES, RUBBER MATS, OR OTHER MEANS AS APPROVED BY THE VILLAGE'S REPRESENTATIVE SHALL BE USED TO PROTECT THE PAVEMENT. THE COST OF THIS WORK SHALL BE INCLUDED IN THE UNIT PRICE BID FOR THE VARIOUS ITEMS OF THE CONTRACT.

CONSTRUCTION NOISE

IN ORDER TO MINIMIZE ANY ADVERSE CONSTRUCTION NOISE IMPACTS, ANY POWER–OPERATED CONSTRUCTION–TYPE DEVICES SHALL NOT BE OPERATED BETWEEN THE HOURS SPECIFIED IN THE VILLAGE NOISE ORDINANCE. IF THERE IS NO NOISE ORDINANCE IN PLACE, POWER–OPERATED CONSTRUCTION–TYPE DEVICES SHALL NOT BE OPERATED BETWEEN THE HOURS OF 7:00 PM TO 7:00AM.

GRAFFITI AND VANDALISM

THE CONTRACTOR SHALL BE RESPONSIBLE FOR REMOVAL AND REPLACEMENT OF ANY CONCRETE WORK OR OTHER PAY ITEM UNDER THIS CONTRACT WHICH IS DEEMED UNACCEPTABLE BY THE VILLAGE DUE TO GRAFFITI OR VANDALISM DAMAGE.

WORK LIMITS

ALL WORK SHALL BE WITHIN EXISTING OR PROPOSED RIGHT–OF–WAY AND/OR CONSTRUCTION LIMITS UNLESS OTHERWISE INSTRUCTED BY THE VILLAGE.

THE WORK LIMITS SHOWN ON THESE PLANS ARE FOR PHYSICAL CONSTRUCTION ONLY. THE INSTALLATION AND OPERATION OF ALL TEMPORARY TRAFFIC CONTROL AND TEMPORARY TRAFFIC CONTROL DEVICES REQUIRED BY THESE PLANS SHALL BE PROVIDED BY THE CONTRACTOR WHETHER INSIDE OR OUTSIDE THESE WORK LIMITS.

ASPHALT

ALL ODOT CONSTRUCTION AND MATERIAL SPECIFICATIONS SHALL APPLY TO THIS PROJECT, EXCLUDING THE BINDER PRICE ADJUSTMENT PER ODOT 401.20. ALL ASPHALT DELIVERED SHALL BE ACCOMPANIED WITH A LOAD TICKET AS PER ITEM 401.21.

ESTIMATED AND CONTINGENT QUANTITIES

THESE PLANS INCLUDE ESTIMATED AND CONTINGENCY QUANTITIES THAT MAY OR MAY NOT BE USED. ANY UNUSED MATERIAL PURCHASED BY THE CONTRACTOR WILL NOT BE PURCHASED OR REIMBURSED BY THE VILLAGE. THE VILLAGE WILL NOT APPROVE ANY WORK DELAYS BECAUSE OF THE LACK OF MATERIALS AT THE SITE. ANY RESTOCKING FEES THAT MAY BE CHARGED WILL ALSO BE THE RESPONSIBILITY OF THE CONTRACTOR.

THE FOLLOWING CONTINGENT QUANTITIES HAVE BEEN INCLUDED IN THE ESTIMATE FOR POSSIBLE FIELD MODIFICATION BY THE VILLAGE AT THEIR DISCRETION:

ITEM 253 FULL–DEPTH PAVEMENT REPAIR 75 CY

CAD FILE DISCLAIMER

THE CAD FILE ASSOCIATED WITH THESE CONSTRUCTION PLANS IS A NON–CERTIFIED DOCUMENT. ANY USE OF THE INFORMATION OBTAINED OR DERIVED FROM THE ASSOCIATED CAD FILE WILL BE AT THE RECEIVING PARTY/USER'S RISK. CHOICE ONE ENGINEERING CORP. OFFERS NO WARRANTY AS TO THE ACCURACY OF THE INFORMATION IN THE CAD FILE OR THAT REVISIONS HAVE BEEN ISSUED AFTER THE CAD DRAWING WAS RELEASED. RECEIVING PARTIES/USERS SHALL HOLD HARMLESS TO THE MAXIMUM EXTENT ALLOWED BY LAW CHOICE ONE ENGINEERING CORP. FROM ANY USE OF THE CAD FILE BY THE RECEIVING PARTY/USER. IN ALL CIRCUMSTANCES, AND AT ALL TIMES, THE PUBLISHED PAPER AND/OR PDF DRAWINGS FOR THE PROJECT SHALL SUPERSEDE THE CAD FILES. IN THE CASE OF AN INCONSISTENCY BETWEEN THE PUBLISHED PAPER/PDF DRAWINGS AND THE ASSOCIATED CAD FILE, THE PUBLISHED PAPER/PDF DRAWINGS SHALL GOVERN THE PROJECT AND ALL WORK.

ITEM 202 REMOVED, AS PER PLAN

THIS ITEM OF WORK SHALL CONSIST OF THE WORK AS DESCRIBED IN OHIO DEPARTMENT OF TRANSPORTATION ITEM 202 REMOVAL OF STRUCTURES AND OBSTRUCTIONS, EXCEPT AS HEREIN MODIFIED.

ITEM 202 REMOVED, AS PER PLAN CONSISTS OF ALL ITEMS THAT DO NOT HAVE AN INDIVIDUAL REMOVAL BID ITEM, AS NECESSARY FOR THE CONSTRUCTION OF THE PROJECT, INCLUDING SAWCUTTING PAVEMENT.

THE FOLLOWING ODOT 202 ITEMS (PIPE REMOVED, MANHOLE REMOVED, AND CATCH BASIN AND INLET REMOVED) SHALL REFER TO ANY PIPE OR STRUCTURE THAT IS TO BE REMOVED OUTSIDE THE LIMITS OF ANY PROPOSED CONDUIT AND/OR STRUCTURE TRENCH AND SHALL BE PAID FOR UNDER EACH OF THOSE INDIVIDUAL REMOVED LINE ITEMS. ALL EXISTING PIPE, MANHOLE, CATCH BASIN, AND INLET LOCATED WITHIN THE TRENCH LIMITS OF ANY PROPOSED CONDUIT AND/OR STRUCTURE SHALL BE REMOVED FOR THE PROPER INSTALLATION OF THAT ITEM AND ANY ASSOCIATED REMOVAL COSTS SHALL BE INCLUDED IN THE COST OF THAT PROPOSED CONDUIT OR STRUCTURE ITEM. THE TRENCH LIMITS SHALL BE BASED ON THE TRENCH DETAIL SHOWN IN THE CONSTRUCTION PLANS.

ANY ITEM THAT IS REMOVED UNDER OR WITHIN 5' OF PROPOSED CURB, PAVEMENT, SIDEWALK, OR DRIVEWAY SHALL BE BACKFILLED AND COMPACTED USING ONLY ODOT ITEM 703.11 STRUCTURAL BACKFILL TYPE 1 OR 2 STRUCTURAL MATERIAL.

THE CONTRACTOR SHALL SAWCUT ALL EXISTING PAVEMENT, SIDEWALK AND CURB AGAINST WHICH ALL IMPROVEMENTS ARE PROPOSED. PAVEMENT, WALK, AND CURB SHALL BE SAWCUT IN NEAT, STRAIGHT LINES. SAWCUT PAVEMENT JOINTS SHALL BE INCLUDED IN THE PAYMENT OF THIS ITEM. MORE THAN ONE SAWCUT MAY BE NECESSARY TO ENSURE A CLEAN CUT ON THE VERTICAL FACE OF SAWCUT JOINTS PRIOR TO PAVING AS PER 401.14. AFTER THE ASPHALT WORK IS COMPLETED, THE TRANSVERSE JOINTS SHALL BE SEALED WITH LIQUID ASPHALT, PER 401.22, 409.02 AND 409.03.

REVISIONS:

FILE NAME
GNA

DRAWN BY
JET

CHECKED BY
NNS

PROJECT No.
WARSLE2003

DATE
05–3–2021

SHEET NUMBER

3 OF 18

ANY PRIVATE PROPERTY WITHIN THE ROAD RIGHT-OF-WAY OR PROJECT CONSTRUCTION LIMITS SHALL BE REMOVED CAREFULLY AND STORED FOR THE PROPERTY OWNER AT A PLACE DESIGNATED BY THE PROPERTY OWNER ON THAT PARTICULAR PROPERTY. ANY SALVAGED PUBLIC ITEMS SHALL REMAIN CITY PROPERTY AND SHALL BE CAREFULLY REMOVED BY THE CONTRACTOR AND STORED AT A DESIGNATED LOCATION ON THE PROJECT SITE FOR CITY PICKUP.

PAYMENT FOR ITEM 202 REMOVED, AS PER PLAN, FOR ALL OPERATIONS DESCRIBED ABOVE SHALL BE AT THE CONTRACT LUMP SUM BID PRICE AND SHALL INCLUDE ALL LABOR, MATERIAL, AND EQUIPMENT REQUIRED TO COMPLETE THIS ITEM OF WORK.

ITEM 452 NON-REINFORCED CONCRETE PAVEMENT, AS PER PLAN

THIS ITEM OF WORK SHALL CONSIST OF THE WORK AS DESCRIBED IN OHIO DEPARTMENT OF TRANSPORTATION ITEM 452 NON-REINFORCED PORTLAND CEMENT CONCRETE PAVEMENT, EXCEPT AS HEREIN MODIFIED.

REMOVAL AND DISPOSAL OF EXISTING DRIVE MATERIALS SHALL BE INCLUDED IN THIS ITEM.

CONCRETE SHALL BE ODOT CLASS QC-1P. CONTRACTOR TO PROVIDE THE CONCRETE WITH A BROOM FINISH AND TOOLED EDGES PER 451.10. CONTRACTOR TO PROVIDE 1/2" PREMOLDED EXPANSION JOINT TO ISOLATE THE APPROACHES FROM WALKS, CURB, AND EXISTING CONCRETE DRIVEWAY. DRIVE APPROACHES SHALL BE INSTALLED PER THE DETAIL IN THESE PLANS THE DRIVEWAY COMPOSITION SHALL BE PER THE HATCH LEGEND SHOWN IN THESE PLANS.

PAVEMENT FOR ITEM 452 NON-REINFORCED CONCRETE PAVEMENT, AS PER PLAN, FOR ALL OPERATIONS DESCRIBED ABOVE SHALL BE AT THE CONTRACT SQUARE YARD BID PRICE AND SHALL INCLUDE ALL MATERIAL, LABOR, AND EQUIPMENT REQUIRED TO COMPLETE THIS ITEM OF WORK.

ITEM 611 CONDUITS/STRUCTURES AND RELATED WORK

THIS ITEM OF WORK SHALL CONSIST OF THE WORK AS DESCRIBED IN OHIO DEPARTMENT OF TRANSPORTATION ITEM 611, PIPE CULVERTS, SEWERS, DRAINS, AND DRAINAGE STRUCTURES, EXCEPT AS HEREIN MODIFIED.

THE INSTALLATION OF ALL STORM SEWER, SANITARY SEWER, AND ALL CORRESPONDING STRUCTURES SHALL BE PER MANUFACTURER'S RECOMMENDATIONS OR AS NOTED ON THE PLANS. THE CONTRACTOR SHALL BE REQUIRED TO MAINTAIN A HIGH STANDARD OF WORK. AND ENSURE THAT ALL ITEMS ARE FULLY AND PROPERLY FUNCTIONAL TO A QUALITY ACCEPTABLE TO THE OWNER.

ALL PIPE CULVERTS, CONDUITS, SEWERS, DRAINS, AND DRAINAGE STRUCTURES SHALL MEET THE MATERIAL REQUIREMENTS OF THIS ITEM. THE FOLLOWING ITEMS WILL NOT BE REQUIRED UNLESS OTHERWISE NOTED: 1) INSTALLATION PLAN, 2) CONSTRUCTION INSPECTION FORMS, 3) PERFORMANCE INSPECTIONS AND REPORTS, 4) CONDUIT AND DRAINAGE STRUCTURE EVALUATIONS.

THE CONTRACTOR SHALL ENSURE THE CONDUIT BEDDING AND BACKFILL COMPACTION DENSITY MEETS ASTM D698 (98% STANDARD PROCTOR). TESTING MAY BE REQUIRED IF DEEMED NECESSARY BY THE OWNER OR THE OWNER'S REPRESENTATIVE.

ITEM 614 MAINTAINING TRAFFIC

IT IS THE INTENTION TO PERFORM THE REQUIRED WORK WITHIN THESE PLANS WITH THE LEAST INCONVENIENCE TO, AND THE MAXIMUM SAFETY OF, THE CONTRACTOR, LOCAL MERCHANTS, PEDESTRIAN TRAFFIC, AND THE TRAVELING PUBLIC.

REQUIREMENTS FOR MAINTAINING TRAFFIC AS SPECIFIED IN THE "OHIO MANUAL OF UNIFORM TRAFFIC CONTROL DEVICES FOR STREETS AND HIGHWAYS" (CURRENT EDITION, LATEST REVISION), PERTINENT PROVISIONS OF THE "OHIO DEPARTMENT OF TRANSPORTATION CONSTRUCTION AND MATERIAL SPECIFICATIONS" (INCLUDING SUPPLEMENTAL SPECIFICATIONS) AND APPLICABLE STANDARD CONSTRUCTION DRAWINGS SHALL APPLY TO THIS PROJECT IN ADDITION TO THE FOLLOWING NOTES.

THE CONTRACTOR SHALL BE RESPONSIBLE FOR MAINTAINING SAFE AND EFFECTIVE VEHICULAR TRAFFIC CONTROL 24 HOURS A DAY FOR THE DURATION OF THIS PROJECT. THIS WILL INCLUDE PROVIDING, PLACING, MAINTAINING, AND SUBSEQUENTLY REMOVING ALL NECESSARY TRAFFIC CONTROL MEASURES FOR ALL PROPOSED CONSTRUCTION OPERATIONS.

BEFORE THE WORK BEGINS, THE CONTRACTOR SHALL SUBMIT TO THE VILLAGE THE NAME(S) AND TELEPHONE NUMBER(S) OF A PERSON OR PERSONS WHO CAN BE CONTACTED TWENTY-FOUR (24) HOURS A DAY BY THE VILLAGE, OR ANY OTHER INTERESTED POLICE AGENCY. THIS PERSON OR PERSONS SHALL BE RESPONSIBLE FOR REPAIRING AND/OR REPLACING ALL TRAFFIC CONTROL DEVICES NEEDED TO MAINTAIN THE SAFETY OF THE TRAVELED PAVEMENT FOR THE

DURATION OF THIS PROJECT. THIS PERSON SHALL HAVE AVAILABLE ALL MATERIALS, EQUIPMENT, AND INCIDENTALS NECESSARY TO PERFORM THE REQUIRED REPAIRS WITHIN A REASONABLE PERIOD OF TIME AS PER C.M.S. 614.14.

THE CONTRACTOR SHALL ALSO SUBMIT A CONSTRUCTION SEQUENCING SCHEDULE PRIOR TO WORK BEGINNING FOR APPROVAL BY THE CITY. THE CONSTRUCTION SEQUENCING SCHEDULE SHALL TAKE INTO CONSIDERATION ALL ASPECTS OF THE PROJECT INCLUDING HOW LOCAL TRAFFIC TO THE BUSINESSES WILL BE MAINTAINED. THE CONSTRUCTION SEQUENCE WILL NEED TO BE APPROVED BY THE VILLAGE PRIOR TO ANY COMMENCEMENT OF WORK.

ACCESS FOR PROPERTY OWNERS AND BUSINESS TRAFFIC SHALL BE MAINTAINED IN A UNIFORM PATTERN THROUGHOUT THE ENTIRE LENGTH OF THE PROJECT AND SHALL NOT BE SUBJECTED TO CONSTANT LANE SHIFTS.

ACCESS TO AND FROM ALL LOCAL RESIDENTIAL AND BUSINESS DRIVES WITHIN THE LIMITS OF THIS PROJECT SHALL BE MAINTAINED AT ALL TIMES (24 HOURS A DAY) BY USING THE EXISTING PAVEMENT, TEMPORARY PAVEMENT, AND THE PROPOSED PAVEMENT UNLESS OTHERWISE DIRECTED BY THE ENGINEER. IT IS THE CONTRACTOR'S RESPONSIBILITY TO SEQUENCE HIS WORK TO HELP MINIMIZE THE NEED FOR TEMPORARY AGGREGATE PAVEMENT. TEMPORARY AGGREGATE PAVEMENT CAN BE ASPHALT GRINDINGS OR OTHER AGGREGATE APPROVED BY THE VILLAGE. THE COST OF INSTALLATION, MATERIAL, AND REMOVAL OF THE TEMPORARY AGGREGATE PAVEMENT IS TO BE PART OF THE LUMP SUM BID FOR ITEM 614 MAINTAINING TRAFFIC.

WHERE MORE THAN ONE ACCESS TO A BUSINESS OR RESIDENCE EXISTS, ONLY ONE ACCESS NEEDS TO BE MAINTAINED AT A TIME DURING CONSTRUCTION. WHEN A BUSINESS OR RESIDENCE ONLY HAS ONE ACCESS DRIVE, ACCESS SHALL BE MAINTAINED AT ALL TIMES. IF THE PROJECT REQUIRES IMPROVEMENTS TO THIS ACCESS DRIVE, THE CONTRACTOR SHALL REPLACE HALF OF THE DRIVE AT ONE TIME TO ALLOW ACCESS AT ALL TIMES. THESE ACCESS OPTIONS ARE SUBJECT TO THE APPROVAL OF THE VILLAGE.

ONCE THE ROADWAY IS CLOSED, IT WILL ONLY BE OPEN TO LOCAL TRAFFIC UNTIL THE PAVEMENT MARKINGS ARE PLACED ON THE NEW ROADWAY.

THE CONTRACTOR SHALL PROVIDE, ERECT AND MAINTAIN SIGNS AND SIGN SUPPORTS, AND CONSTRUCTION BARRELS AS DETAILED IN THE "OHIO MANUAL OF UNIFORM TRAFFIC CONTROL DEVICES," AND TYPE III BARRICADES WITH THE SIGN R11-3-60 ("ROAD CLOSED, LOCAL TRAFFIC ONLY") OF THE TYPE AND LOCATION AS FOLLOWS:

INTERSECTION OF MASON MORROW MILLGROVE ROAD AND LEBANON ROAD

INTERSECTION OF HUFFORD STREET AND LEBANON ROAD
 INTERSECTION OF HAYNER ROAD AND LEBANON ROAD
 INTERSECTION OF CORWIN NIXON BOULEVARD AND LEBANON ROAD

THE CONTRACTOR SHALL NOTIFY THE VILLAGE 21 DAYS PRIOR TO THE START OF ANY DETOUR OR LANE RESTRICTIONS. THE VILLAGE IS REQUIRED TO PROVIDE A 14 DAY NOTIFICATION PRIOR TO THE START OF DETOUR/LANE RESTRICTIONS TO ODOT, LOCAL SCHOOLS, AND EMERGENCY SERVICES. THIS DETOUR/LANE RESTRICTION COMMUNICATION MUST STATE THE DATE OF CLOSURE AND LENGTH OF CLOSURE.

ANY DAMAGE TO MAINTENANCE OF TRAFFIC EQUIPMENT SUCH AS SIGNS, BARRELS, ETC. SHALL BE THE RESPONSIBILITY OF THE CONTRACTOR.

THE CONTRACTOR WILL BE REQUIRED TO PROVIDE, ERECT, MAINTAIN (IN PROPER POSITION, CLEAN AND LEGIBLE, AND IN GOOD WORKING CONDITION), AND SUBSEQUENTLY REMOVE ALL LIGHTS, SIGNS, CONES, BARRICADES, EXISTING PAVEMENT MARKINGS, AND ANY OTHER TRAFFIC CONTROL DEVICES NECESSARY FOR THE MAINTENANCE OF TRAFFIC.

THE CONTRACTOR SHALL ADJUST THE LOCATION AND/OR SPACING OF ALL TRAFFIC CONTROL CHANNELING DEVICES AS DICTATED BY THE PROGRESS OF THE REQUIRED WORK TO ALLOW CONSTRUCTION ACCESS TO WORK AREAS WHILE MAINTAINING SAFE AND EFFECTIVE TRAFFIC CONTROL DURING ALL CONSTRUCTION OPERATIONS. THE ORIGINAL LOCATION, PLACEMENT, SPACING AND SUBSEQUENT RELOCATION OR REMOVAL OF ALL TRAFFIC CONTROL DEVICES SHALL BE SUBJECT TO THE VILLAGE'S APPROVAL.

IT IS INTENDED THAT THE LOCAL TRAFFIC NOT BE SUBJECTED TO ANY LANE CLOSURES UNLESS ACTIVE WORK IS BEING PERFORMED IN OR IMMEDIATELY ADJACENT TO THE CLOSED LANE. THE ROADWAY SHALL NOT BE RESTRICTED TO ANY LANE CLOSURE DURING PERIODS OF INTERMITTENT OR IRREGULAR WORK, NOR CLOSED SOLELY FOR THE CONVENIENCE OF THE CONTRACTOR. THE VILLAGE SHALL MAKE THE FINAL DETERMINATION AS TO WHAT CONSTITUTES ACTIVE WORK AND WHETHER OR NOT THE LANE CLOSURE IS JUSTIFIED. IF, IN THE OPINION OF THE VILLAGE, THE LANE CLOSURE IS NOT JUSTIFIED, THEY MAY ORDER ALL OR PART OF THE LANE CLOSURE REOPENED TO LOCAL TRAFFIC (UNTIL SUCH TIME THIS CONDITION IS CORRECTED.) THE CONTRACTOR SHALL FURNISH AND INSTALL ADVANCE WARNING

"ROAD WORK AHEAD" (W20-1) SIGNS AND "END ROAD WORK" (G20-2) SIGNS, PLACED AT EACH CROSSROAD IN THE PROJECT AREA, AS WELL AS OTHER NECESSARY MAINTENANCE OF TRAFFIC SIGNS.

THE CONTRACTOR SHALL NOTIFY THE VILLAGE OF ANY INTENDED CHANGES TO ANY EXISTING OR TEMPORARY TRAFFIC CONTROL DEVICES AND SHALL OBTAIN THE CITY'S APPROVAL PRIOR TO MAKING THE CHANGES. THE CONTRACTOR SHALL ALSO NOTIFY THE CITY AND LOCAL NEWSPAPER FORTY-EIGHT (48) HOURS IN ADVANCE OF ANY INTENDED LANE CLOSURES.

MAINTENANCE OF TRAFFIC WILL BE PERFORMED IN PHASES DURING CONSTRUCTION OF THE PROPOSED PROJECT. ALL PHASES INVOLVE DETOURS. NOTICES OF THE DETOURS WILL BE POSTED IN THE LOCAL MEDIA PRIOR TO THE ROAD CLOSURES, AND EMERGENCY SERVICES WILL ALSO BE NOTIFIED. ACCESS FOR LOCAL TRAFFIC WILL BE PROVIDED AT ALL TIMES DURING THE ROAD CLOSURES. ACCESS FOR PROPERTY OWNERS AND BUSINESS TRAFFIC WILL BE MAINTAINED AT ALL TIMES DURING CONSTRUCTION OF THE PROJECT. AT LEAST ONE DRIVE WILL BE MAINTAINED FOR EACH RESIDENCE AND BUSINESS THROUGHOUT THE PROJECT AREA.

ITEM 623 CONSTRUCTION LAYOUT STAKES AND SURVEYING, AS PER PLAN

THIS ITEM OF WORK SHALL CONSIST OF THE WORK AS DESCRIBED IN OHIO DEPARTMENT OF TRANSPORTATION ITEM 623 CONSTRUCTION LAYOUT STAKES, EXCEPT AS HEREIN MODIFIED.

THE VERTICAL CONTROL IS LISTED ON THE PLANS WITH THE BENCHMARKS. TRAVERSE POINTS ARE SHOWN BELOW FOR HORIZONTAL CONTROL. THE BEARINGS ARE LISTED FOR THE CENTERLINE OF CONSTRUCTION.

PAYMENT FOR ITEM 623 CONSTRUCTION LAYOUT STAKES, AS PER PLAN, FOR ALL OPERATIONS DESCRIBED ABOVE SHALL BE AT THE CONTRACT LUMP SUM BID PRICE AND SHALL INCLUDE ALL LABOR, MATERIAL, AND EQUIPMENT, REQUIRED TO COMPLETE THIS ITEM OF WORK.

POINT#	STATION	OFFSET	NORTH	EAST	TYPE	ELEV.
100	09+76.09	6.52' LT.	504892.779	1482447.837	TRAV. PT.	646.14
101	13+72.68	21.05' LT.	505288.312	1482482.310	TRAV. PT.	646.53
10000001	17+45.82	18.68' RT.	505653.529	1482567.751	TRAV. PT.	643.66
103	20+52.05	16.64' LT.	505960.803	1482584.579	TRAV. PT.	638.75
10000002	24+46.65	26.73' RT.	506349.893	1482650.027	TRAV. PT.	635.76

ITEM 659 SEEDING AND MULCHING, CLASS 1, AS PER PLAN

THIS ITEM OF WORK SHALL CONSIST OF THE WORK AS DESCRIBED IN OHIO DEPARTMENT OF TRANSPORTATION ITEM 659, SEEDING AND MULCHING, EXCEPT AS HEREIN MODIFIED.

ALL AREAS DESIGNATED FOR SEEDING SHALL HAVE A MINIMUM OF 3" OF TOPSOIL OVER THE ENTIRE AREA. TESTING THE PH OF ANY EXISTING OR IMPORTED TOPSOIL PER ODOT 659.02 SHALL BE WAIVED. THE AREA SHALL BE HAND-RAKED AND DRESSED READY FOR SEEDING. NO STONE OVER 1" IN SIZE PERMITTED IN THE TOP 3".

SEEDING AND MULCHING SHALL BE APPLIED TO ALL AREAS OF EXPOSED SOIL. QUANTITY CALCULATIONS FOR SEEDING AND MULCHING ARE BASED ON PROJECT WORK LIMITS.

IT'S THE CONTRACTOR'S SOLE RESPONSIBILITY TO PROVIDE THE REQUIRED GERMINATION RATES AND ENSURE THE GRASS IS ESTABLISHED TO THE SATISFACTION OF THE VILLAGE WHICH MAY REQUIRE WATERING, REGRADING/ADDING TOPSOIL AND RESEEDING.

ANY AREAS THAT HAVE ERODED OR WHERE NEW GRASS DID NOT GERMINATE SHALL BE ADDRESSED BY THE CONTRACTOR UNTIL THE AREAS ARE STABILIZED, SHAPED, AND DRAINED, AS INDICATED IN THE PLANS.

ANY DISTURBED AREA, OUTSIDE OF THE PROJECT WORK LIMITS, CAUSED BY THE CONTRACTOR'S WORK, SHALL BE RESTORED TO THE SATISFACTION OF THE PROPERTY OWNER AND VILLAGE, AT THE CONTRACTOR'S SOLE EXPENSE. THIS ITEM INCLUDES: TOPSOIL, SEEDING, MULCHING, COMMERCIAL FERTILIZER, WATER, AND REPAIR SEEDING AND MULCHING.

PAYMENT FOR ITEM 659 SEEDING AND MULCHING, CLASS 1, AS PER PLAN, FOR ALL ABOVE OPERATIONS, SHALL BE AT THE CONTRACT SQUARE YARD BID PRICE AND SHALL INCLUDE ALL LABOR, MATERIAL, AND EQUIPMENT REQUIRED TO COMPLETE THIS ITEM OF WORK.



SIDNEY, OHIO 937.497.0200
 LOVELAND, OHIO 513.239.8554
 WWW.CHOICEONEENGINEERING.COM

LEBANON ROAD IMPROVEMENTS VILLAGE OF SOUTH LEBANON GENERAL NOTES

REVISIONS:

FILE NAME
 GNB

DRAWN BY
 JET

CHECKED BY
 NNS

PROJECT No.
 WARSLE2003

DATE
 05-3-2021

SHEET NUMBER

ESTIMATED QUANTITIES

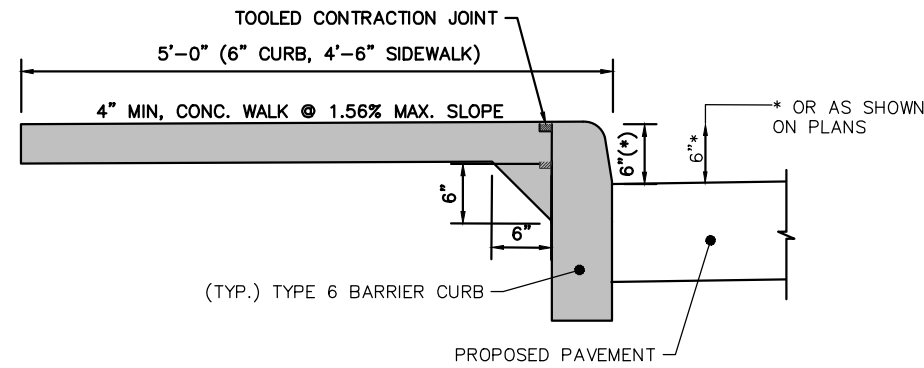

COMBINED CURB AND SIDEWALK

NOTES

NOTES

- A. WALK TO BE POURED ON 4" MIN. COMPACTED STRUCTURAL BEDDING.
- B. PROVIDE BROOM FINISH TO ALL EXPOSED SURFACES.
- C. CONCRETE SHALL CONFORM TO ODOT ITEM 499 CONCRETE. CONCRETE WORK SHALL CONFORM TO ODOT ITEM 608, UNLESS OTHERWISE SPECIFIED WITHIN.
- D. PROVIDE EDGING AROUND ALL EXPOSED SURFACES.
- E. USE WHITE PIGMENTED CURING COMPOUND IMMEDIATELY AFTER FINISHING SURFACES. ANY OTHER METHOD OR TYPE OF CURING COMPOUND MUST BE PREAPPROVED.
- F. ALL CONCRETE SHALL BE ODOT QC MISC. (CEMENT ONLY – NO POZZOLAN MATERIAL).
- G. PROPOSED CONCRETE SIDEWALK SHALL BE JOINTED AS CLOSE TO SQUARE AS POSSIBLE. JOINT SPACING MAY VARY SLIGHTLY DEPENDING ON THE LENGTH AND WIDTH OF THE PROPOSED SIDEWALK AREAS. JOINT SPACING SHALL TYPICALLY RANGE FROM 4'X4' TO 10'X10'. IN ALL CASES THE SIDEWALK SHALL BE JOINTED SO THAT THE MAXIMUM ASPECT RATIO (OF PANEL LENGTH TO WIDTH) OF THE JOINTING IS 1.25:1 OR LESS. CONTRACTOR TO VERIFY METHOD AND TYPE OF CONTROL JOINTING WITH OWNER PRIOR TO PERFORMING WORK.
- H. CURB/SIDEWALK SHALL HAVE EXPANSION JOINTS EVERY 100'.

ITEM NO.	ITEM NO.	DESCRIPTION	UNIT OF MEASURE	APPROX. QTY.
1	201	CLEARING AND GRUBBING	LUMP	1
2	202	REMOVED, AS PER PLAN	LUMP	1
3	202	CURB REMOVED	FT.	738
4	202	WALK REMOVED	S.F.	450
5	202	PIPE REMOVED, 24" AND UNDER	FT.	31
6	202	VALVE BOX REMOVED	EACH	2
7	202	CATCH BASIN REMOVED	EACH	1
8	203	EXCAVATION (INCLUDES ASPHALT PAVEMENT REMOVAL)	C.Y.	120
9	204	SUBGRADE COMPACTION	S.Y.	354
10	253	FULL-DEPTH PAVEMENT REPAIR CONTINGENCY	S.Y.	75
11	254	1-1/2"± PAVEMENT PLANING, ASPHALT CONCRETE	S.Y.	3665
12	301	9" ASPHALT CONCRETE BASE, PG64-22	C.Y.	89
13	301	4" ASPHALT CONCRETE BASE, PG64-22 (DRIVEWAYS)	C.Y.	17
14	304	4" AGGREGATE BASE (SIDEWALK AND CURB RAMPS)	C.Y.	35
15	304	AGGREGATE BASE (DRIVEWAYS)	C.Y.	42
16	407	NON-TRACKING TACK COAT, 0.09 GAL/S.Y.	GAL.	362
17	441	ASPHALT CONCRETE INTERMEDIATE COURSE, TYPE 1, (448)	C.Y.	30
18	441	1-1/2" ASPHALT CONCRETE SURFACE COURSE, TYPE 1, PG 64-22	C.Y.	168
19	441	2" ASPHALT CONCRETE SURFACE COURSE, TYPE 1, (448) PG64-22 (DRIVEWAYS)	C.Y.	8
20	452	6" NON-REINFORCED CONCRETE PAVEMENT, AS PER PLAN	S.Y.	190
21	606	GUARDRAIL REMOVED AND REBUILT	FT.	75
22	608	4" CONCRETE WALK, AS PER PLAN	S.F.	2467
23	608	CURB RAMP	S.F.	360
24	609	TYPE 6 BARRIER CURB, AS PER PLAN	FT.	1027
25	611	4" CONDUIT, TYPE B, 707.45, STORM REPAIR	FT.	10
26	611	6" CONDUIT, TYPE B, 707.45, STORM REPAIR	FT.	10
27	611	8" CONDUIT, TYPE B, 707.45, STORM REPAIR	FT.	10
28	611	12" RCP CL IV STORM SEWER, AS PER PLAN	FT.	69
29	611	TYPE 3A CATCH BASIN	EACH	2
30	611	TYPE 2-2B CATCH BASIN	EACH	1
31	611	CATCH BASIN RECONSTRUCTED TO GRADE	EACH	1
32	611	MANHOLE ADJUSTED TO GRADE	EACH	2
33	614	MAINTAINING TRAFFIC	LUMP	1
34	614	DETOUR SIGNING	LUMP	1
35	623	CONSTRUCTION LAYOUT STAKES AND SURVEYING, AS PER PLAN	LUMP	1
36	630	REMOVAL OF GROUND MOUNTED SIGN/POST AND REERECTION	EACH	2
37	638	VALVE BOX ADJUSTED TO GRADE	EACH	9
38	644	CENTER LINE	MILE	0.25
39	644	STOP LINE	FT.	52
40	644	CROSSWALK LINE	FT.	294
41	644	4" DOTTED LINE	FT.	86
42	659	SEEDING AND MULCHING, TYPE 1, AS PER PLAN	S.Y.	1250

REVISIONS:

FILE NAME
GNC

DRAWN BY
JET

CHECKED BY
NNS

PROJECT No.
WARSLE2003

DATE
05-3-2021

SHEET NUMBER

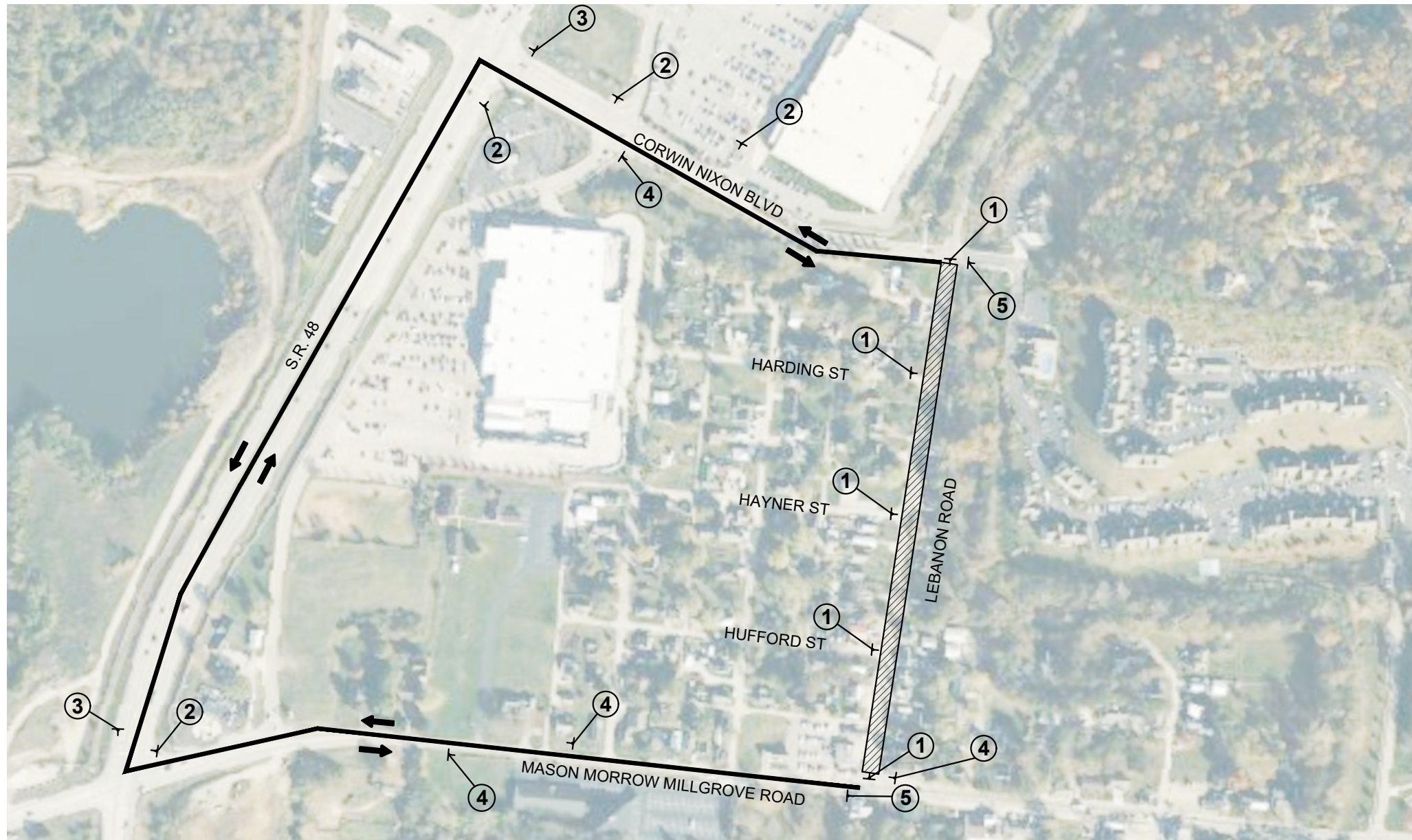

DETOUR PLAN

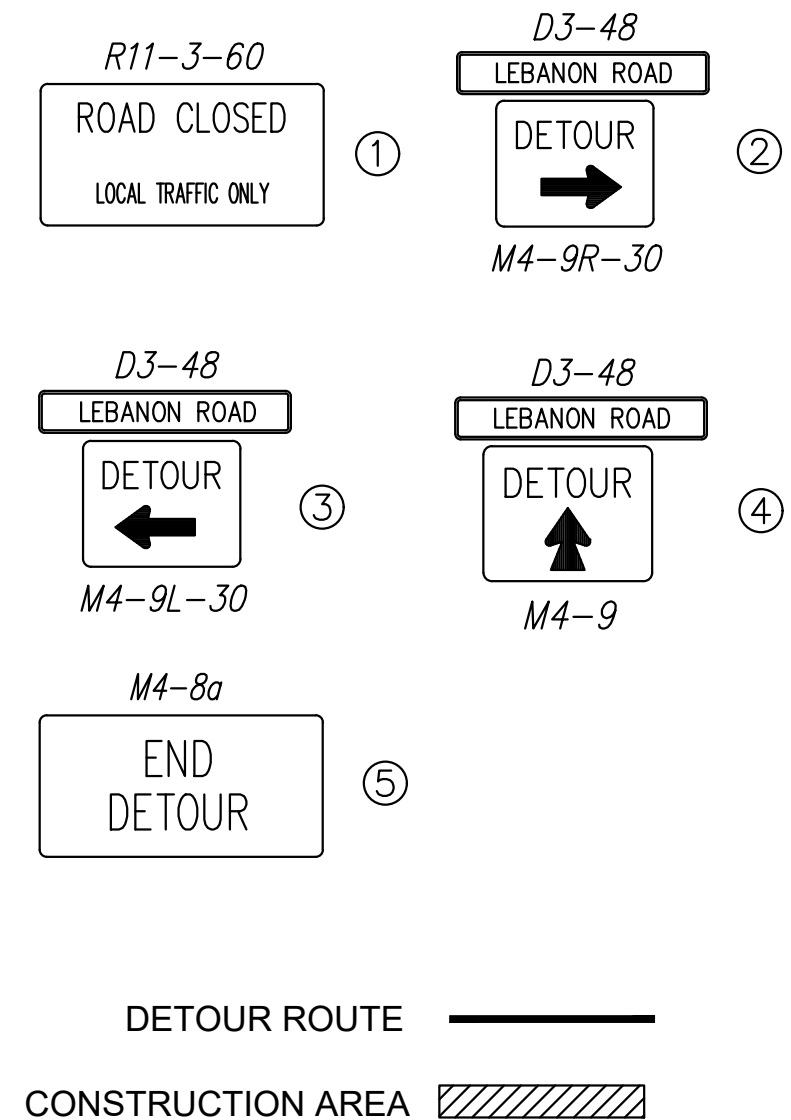

CONSTRUCTION SEQUENCE

THE CONTRACTOR SHALL FURNISH AND INSTALL ADVANCE WARNING "ROAD WORK AHEAD" (W20-1) SIGNS AND "END ROAD WORK" (G20-2) SIGNS AS WELL AS OTHER NECESSARY MAINTENANCE OF TRAFFIC SIGNS AT THE BEGINNING AND END OF THE PROJECT AND ALSO ON ALL CROSSROADS.

THE WORK SHALL CONSIST OF:

THIS PROJECT CONSISTS OF THE INSTALLATION OF SIDEWALK AND REPAVING OF LEBANON ROAD BETWEEN MASON MORROW MILLGROVE ROAD AND CORWIN NIXON BOULEVARD. LEBANON ROAD WILL BE MILLED AND REPAVED WITH THE INSTALLATION OF BARRIER CURB. SIDEWALK WILL BE ATTACHED TO THE CURB AND ON THE WEST SIDE OF THE ROADWAY.

CONTRACTOR SHALL MAINTAIN TRAFFIC AT INTERSECTIONS OF LEBANON ROAD AND PIKE STREET AND THE INTERSECTION OF LEBANON ROAD AND CORWIN NIXON WHILE CONSTRUCTION IS TAKING PLACE. LOCAL TRAFFIC SHALL ALWAYS BE MAINTAINED FOR HOMES ALONG THE PROJECT ROUTE.

OVERNIGHT WEEKEND ACCESS TO DRIVES DURING BASE PREPARATION AND OTHER CONSTRUCTION ACTIVITIES

ACCESS TO DRIVEWAYS DURING OVERNIGHT AND WEEKEND HOURS SHALL BE MAINTAINED THROUGHOUT THE DURATION OF THE PROJECT. TEMPORARY ACCESS SHALL BE PROVIDED TO ALL DRIVEWAYS AND ALLEYS WITH A CHANGE IN ELEVATION FROM DRIVEWAY ACCESS TO TEMPORARY DRIVE RAMP NOT TOT EXCEED 1-1/2".

ACCESS TO ALL INTERSECTIONS SHALL BE MAINTAINED 24 HOURS A DAY. DURING CONSTRUCTION OF UTILITY CROSSINGS, ONE-WAY TRAFFIC SHALL BE MAINTAINED WITH FLAGGER PER THE REQUIREMENTS OF THE OHIO UNIFORM MANUAL OF TRAFFIC CONTROL DEVICES WITH THE APPROVAL OF THE ENGINEER WITH A MINIMUM OF A 11 FOOT WIDE LANE WITH ADEQUATE (30 FOOT) RADII FOR TURNING.

PAYMENT FOR ALL OF THE WORK REQUIRED BY THE CONTRACTOR FOR TRAFFIC CONTROL NOTED ON THIS SHEET INCLUDING PROVIDING, ERECTING, MAINTAINING, AND REMOVING ALL FLASHERS, SIGNS, BARRICADES, SUPPORTS, AND ALL OTHER TRAFFIC CONTROL DEVICES SHALL BE INCLUDED IN THE LUMP SUM BID FOR ITEM 614 DETOUR SIGNING. (THE CONTRACTOR SHALL INSTALL ADVANCE WARNING SIGNS PER STANDARD DRAWING MT-101.60.)

REVISIONS:

FILE NAME
DETOUR

DRAWN BY
JET

CHECKED BY
NNS

PROJECT No.
WARSLE2003

DATE
05-3-2021

SHEET NUMBER

REVISIONS:

FILE NAME
INT. 1

DRAWN BY
JET

CHECKED BY
NNS

PROJECT No.
WARSLE2003

DATE
05-3-2021

SHEET NUMBER

7 OF 18

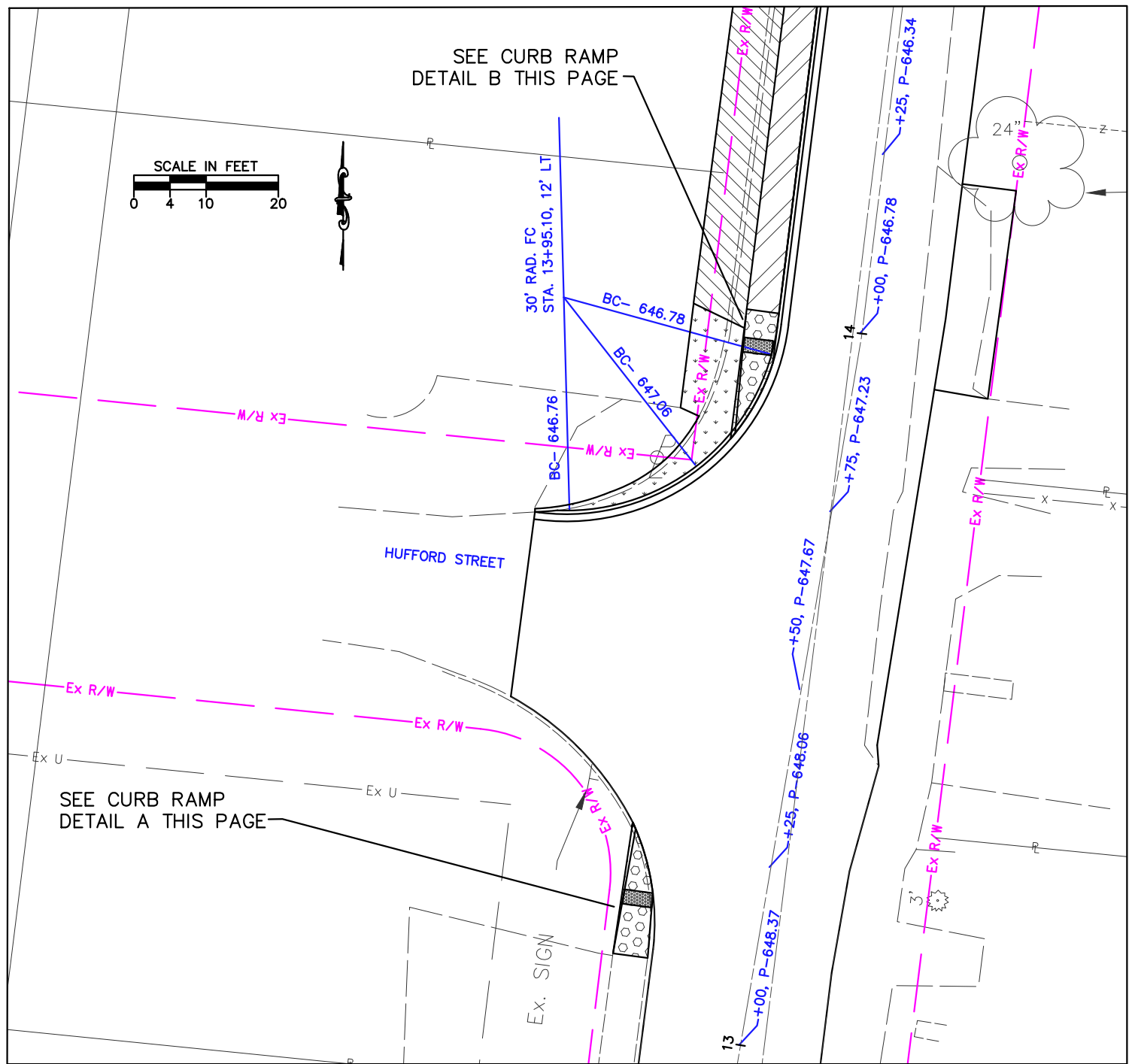

**LEBANON ROAD AND HUFFORD STREET
INTERSECTION**

LEGEND

- BC - PROPOSED BACK OF CURB ELEVATION
- FL - PROPOSED FLOW LINE ELEVATION
- P - PROPOSED PAVEMENT ELEVATION
- FC - PROPOSED FACE OF CURB
- EBC - EXISTING BACK OF CURB ELEVATION
- EFL - EXISTING FLOW LINE ELEVATION
- EP - EXISTING PAVEMENT ELEVATION
- W - PROPOSED WALK ELEVATION
- EW - EXISTING WALK ELEVATION

NOTE: INTERSECTION DETAILS SHOW CURB ELEVATIONS WITHOUT DEPRESSED CURB. CURB RAMP DETAILS SHOW DEPRESSED CURB ELEVATION FOR CURB RAMPS.

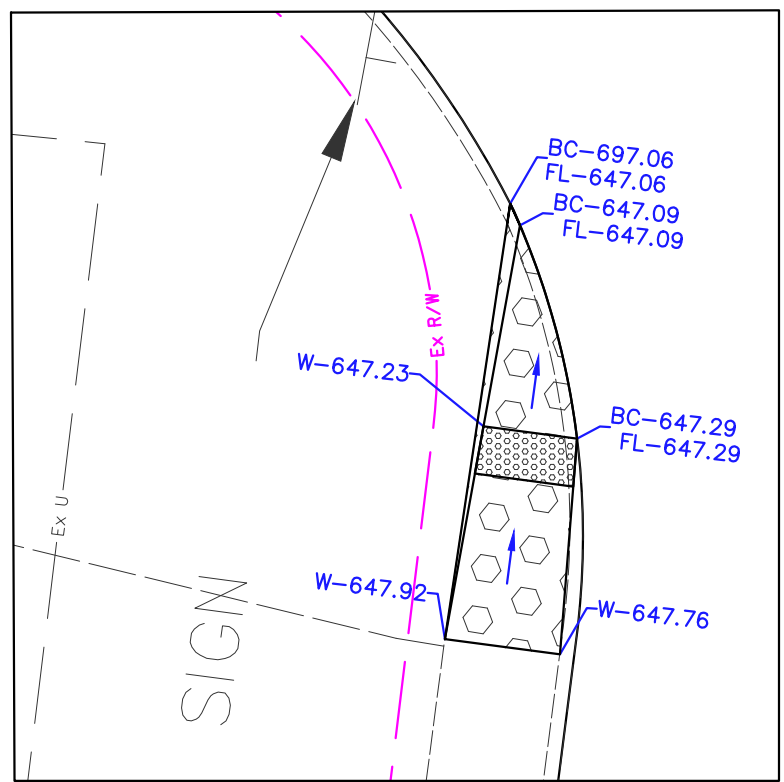
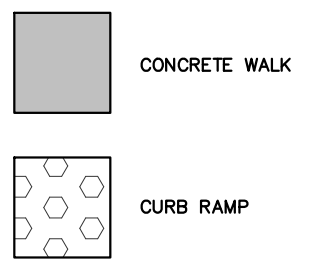

CURB RAMP DETAIL A
ODOT TYPE B3 RAMP
NOT TO SCALE

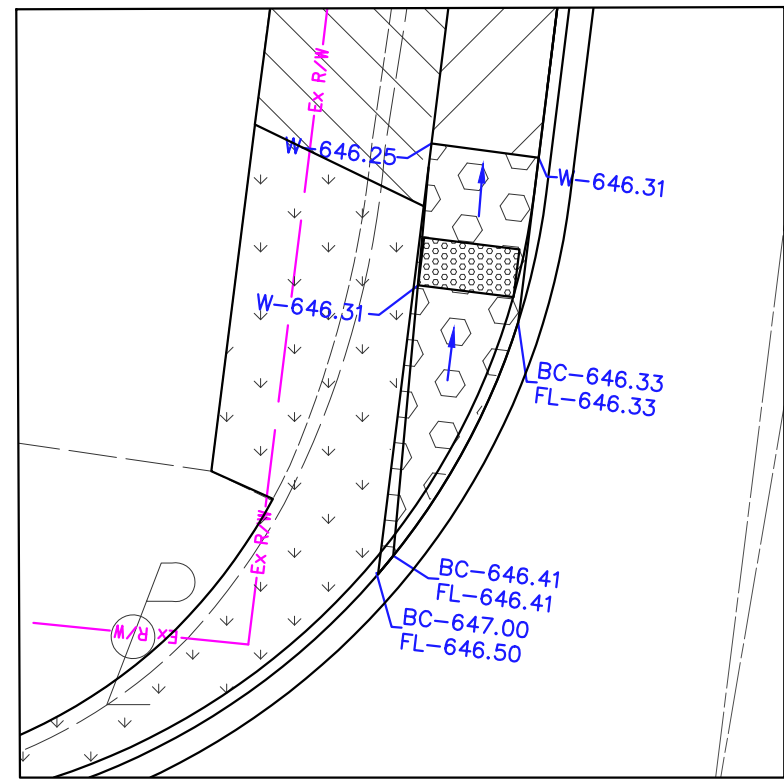

CURB RAMP DETAIL B
ODOT TYPE B3 RAMP
NOT TO SCALE

REVISIONS:

FILE NAME
INT. 2

DRAWN BY
JET

CHECKED BY
NNS

PROJECT No.
WARSLE2003

DATE
05-3-2021

SHEET NUMBER

8 OF 18

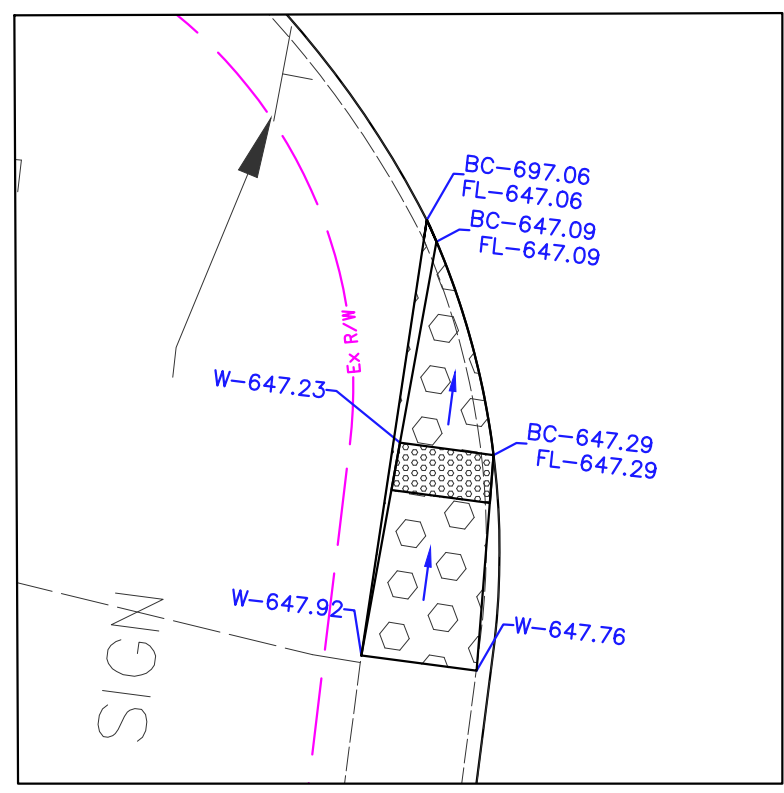
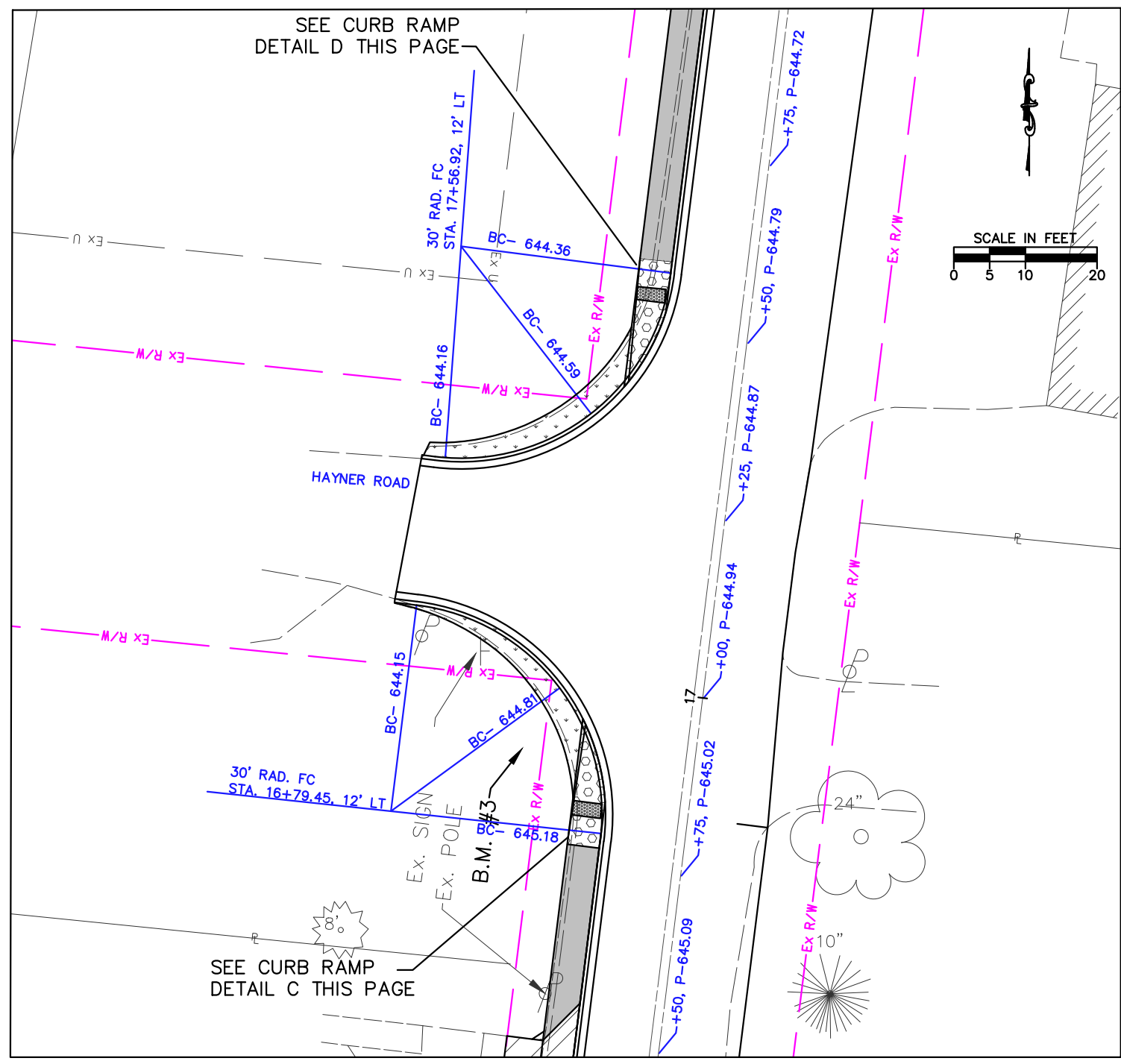

CURB RAMP DETAIL C
ODOT TYPE B3 RAMP
NOT TO SCALE

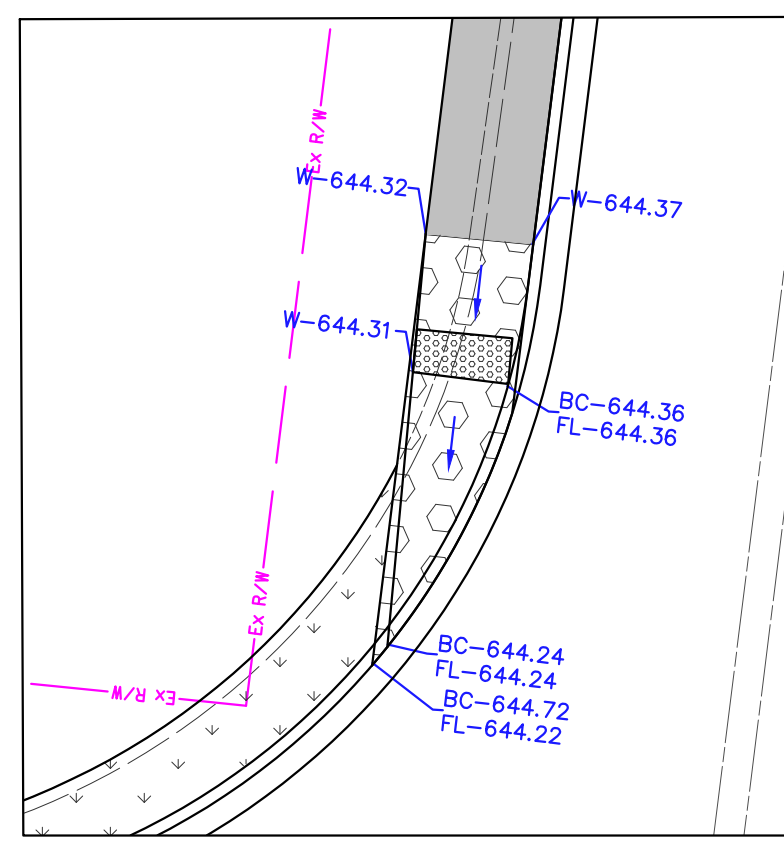

CURB RAMP DETAIL D
ODOT TYPE B3 RAMP
NOT TO SCALE

- LEGEND**
- BC - PROPOSED BACK OF CURB ELEVATION
 - FL - PROPOSED FLOW LINE ELEVATION
 - P - PROPOSED PAVEMENT ELEVATION
 - FC - PROPOSED FACE OF CURB
 - EBC - EXISTING BACK OF CURB ELEVATION
 - EFL - EXISTING FLOW LINE ELEVATION
 - EP - EXISTING PAVEMENT ELEVATION
 - W - PROPOSED WALK ELEVATION
 - EW - EXISTING WALK ELEVATION

**LEBANON ROAD AND HAYNER ROAD
INTERSECTION**

NOTE: INTERSECTION DETAILS SHOW CURB ELEVATIONS
WITHOUT DEPRESSED CURB. CURB RAMP DETAILS
SHOW DEPRESSED CURB ELEVATION FOR CURB RAMP.

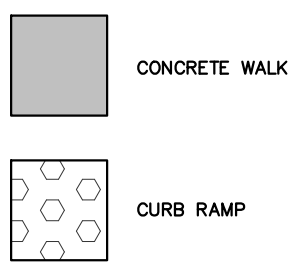

REVISIONS:

FILE NAME
INT. 3

DRAWN BY
JET

CHECKED BY
NNS

PROJECT No.
WARSLE2003

DATE
05-3-2021

SHEET NUMBER

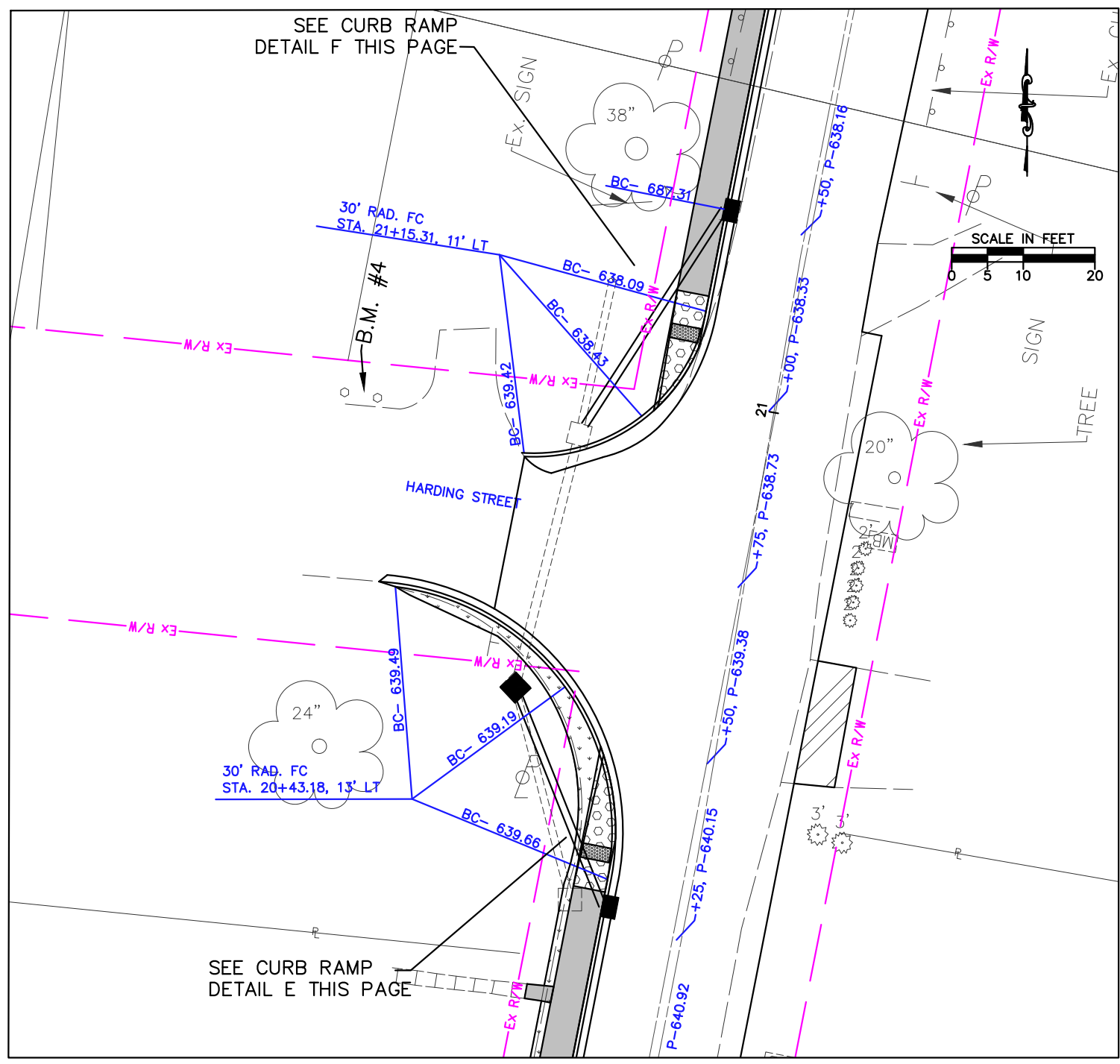

**LEBANON ROAD AND HARDING ROAD
INTERSECTION**

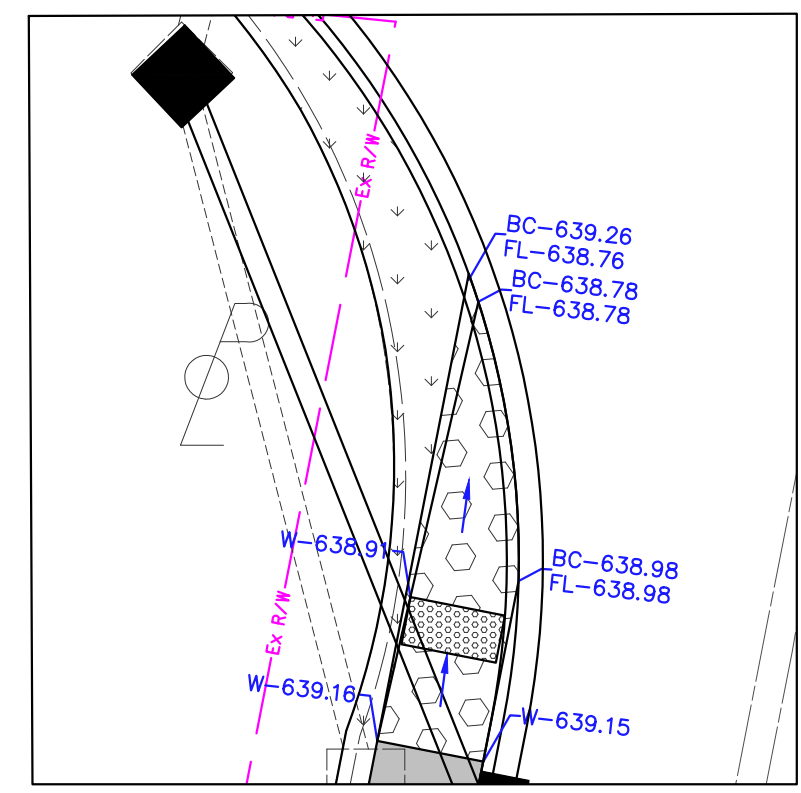
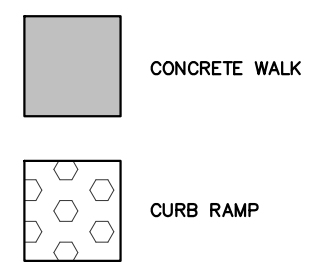

CURB RAMP DETAIL E
ODOT TYPE B3 RAMP
NOT TO SCALE

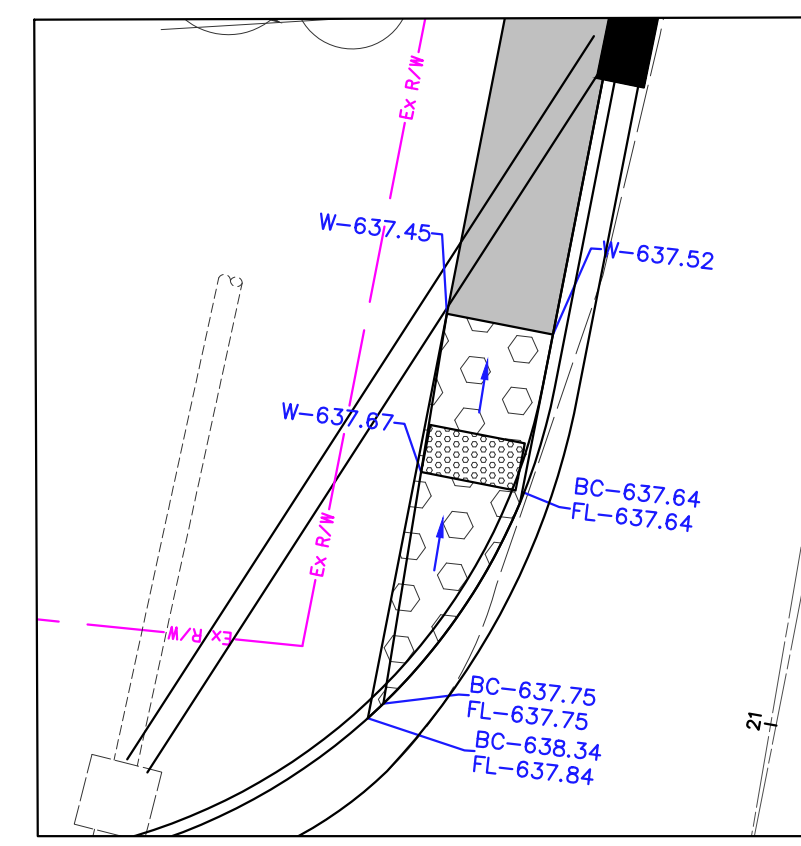

CURB RAMP DETAIL F
ODOT TYPE B3 RAMP
NOT TO SCALE

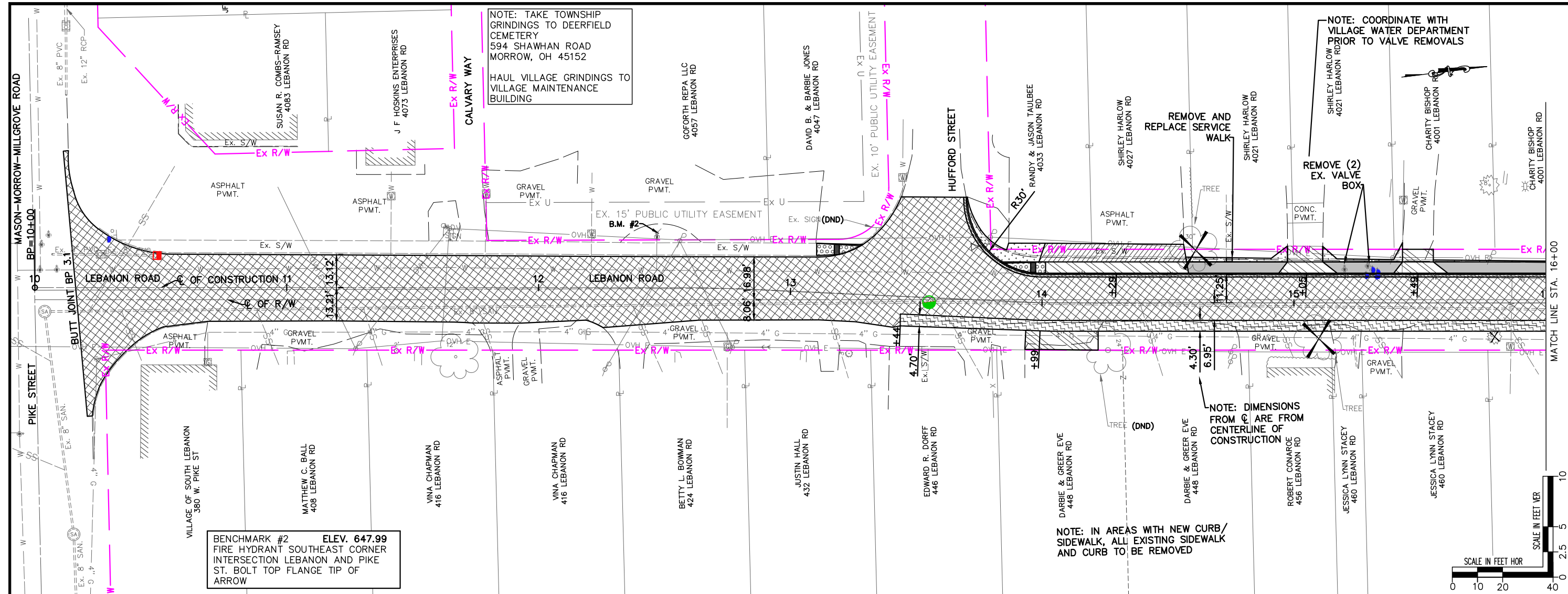

BENCHMARK #2 ELEV. 647.99
FIRE HYDRANT SOUTHEAST CORNER INTERSECTION LEBANON AND PIKE ST. BOLT TOP FLANGE TIP OF ARROW

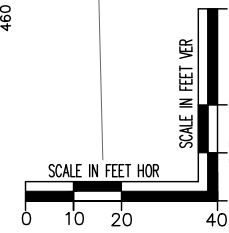
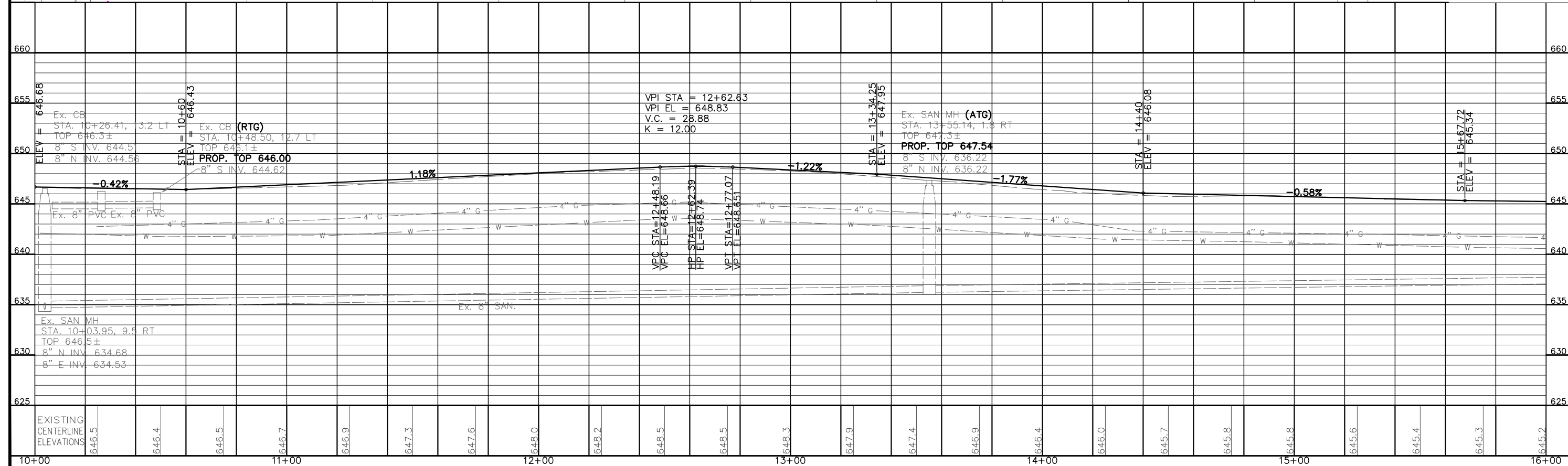

LEBANON ROAD IMPROVEMENTS
VILLAGE OF SOUTH LEBANON
LEBANON ROAD P-P STA. 10+00 TO STA. 16+00

REVISIONS:

FILE NAME	PP-LEBANON ROAD
DRAWN BY	JET
CHECKED BY	NNS
PROJECT No.	WARSLE2003
DATE	05-3-2021
SHEET NUMBER	10 OF 18

**LEBANON ROAD IMPROVEMENTS
VILLAGE OF SOUTH LEBANON**
LEBANON ROAD P-P STA. 16+00 TO STA. 22+00

NOTE: TAKE TOWNSHIP GRINDINGS TO DEERFIELD CEMETERY 594 SHAWHAN ROAD MORROW, OH 45152
HAUL VILLAGE GRINDINGS TO VILLAGE MAINTENANCE BUILDING

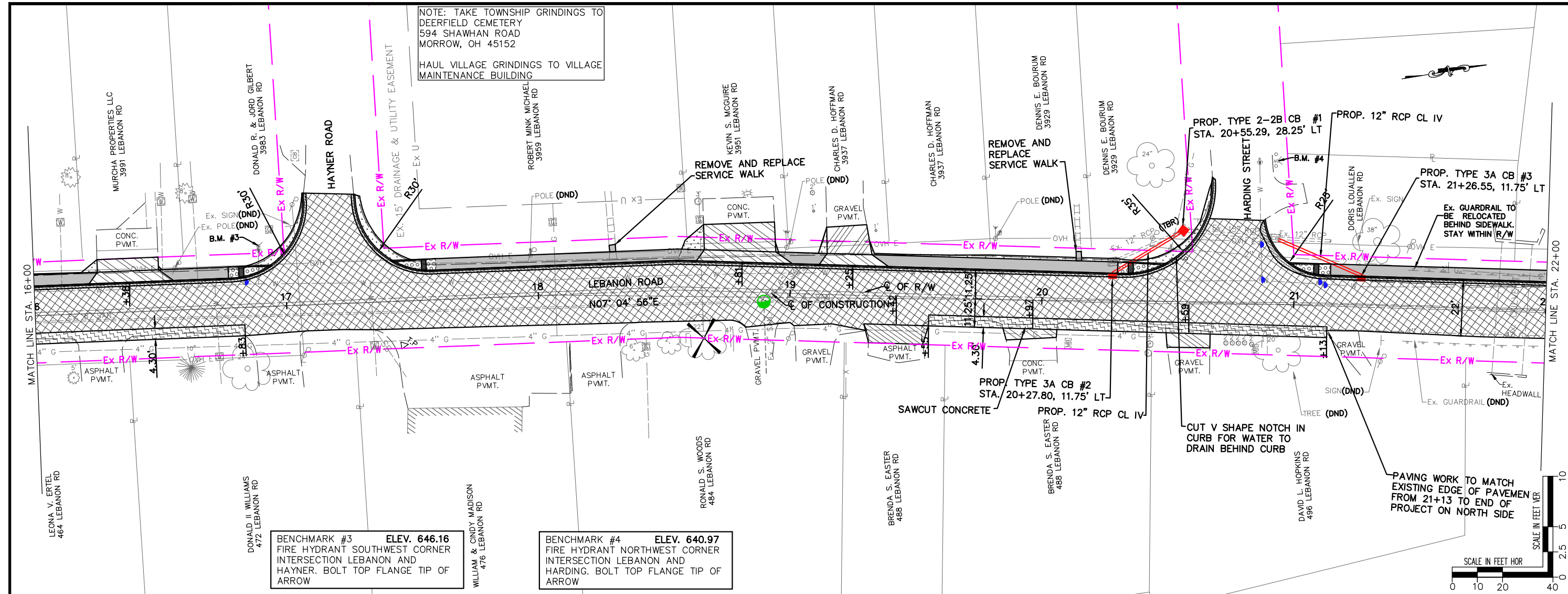

BENCHMARK #3 ELEV. 646.16
FIRE HYDRANT SOUTHWEST CORNER INTERSECTION LEBANON AND HAYNER. BOLT TOP FLANGE TIP OF ARROW

BENCHMARK #4 ELEV. 640.97
FIRE HYDRANT NORTHWEST CORNER INTERSECTION LEBANON AND HARDING. BOLT TOP FLANGE TIP OF ARROW

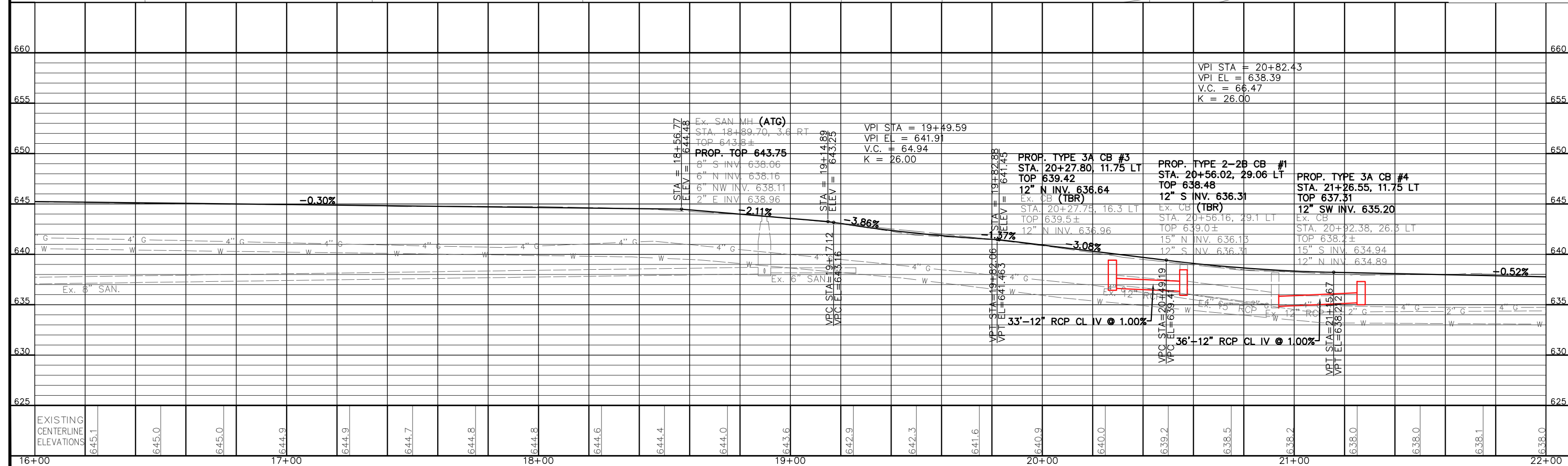
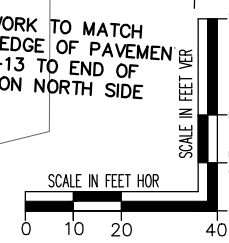

REVISIONS:

FILE NAME	PP-LEBANON ROAD
DRAWN BY	JET
CHECKED BY	NNS
PROJECT No.	WARSLE2003
DATE	05-3-2021
SHEET NUMBER	11 OF 18

**LEBANON ROAD IMPROVEMENTS
VILLAGE OF SOUTH LEBANON**
LEBANON ROAD P-P STA. 22+00 TO STA. 24+00

REVISIONS:

FILE NAME
PP-LEBANON ROAD

DRAWN BY
JET

CHECKED BY
NNS

PROJECT No.
WARSLE2003

DATE
05-3-2021

SHEET NUMBER

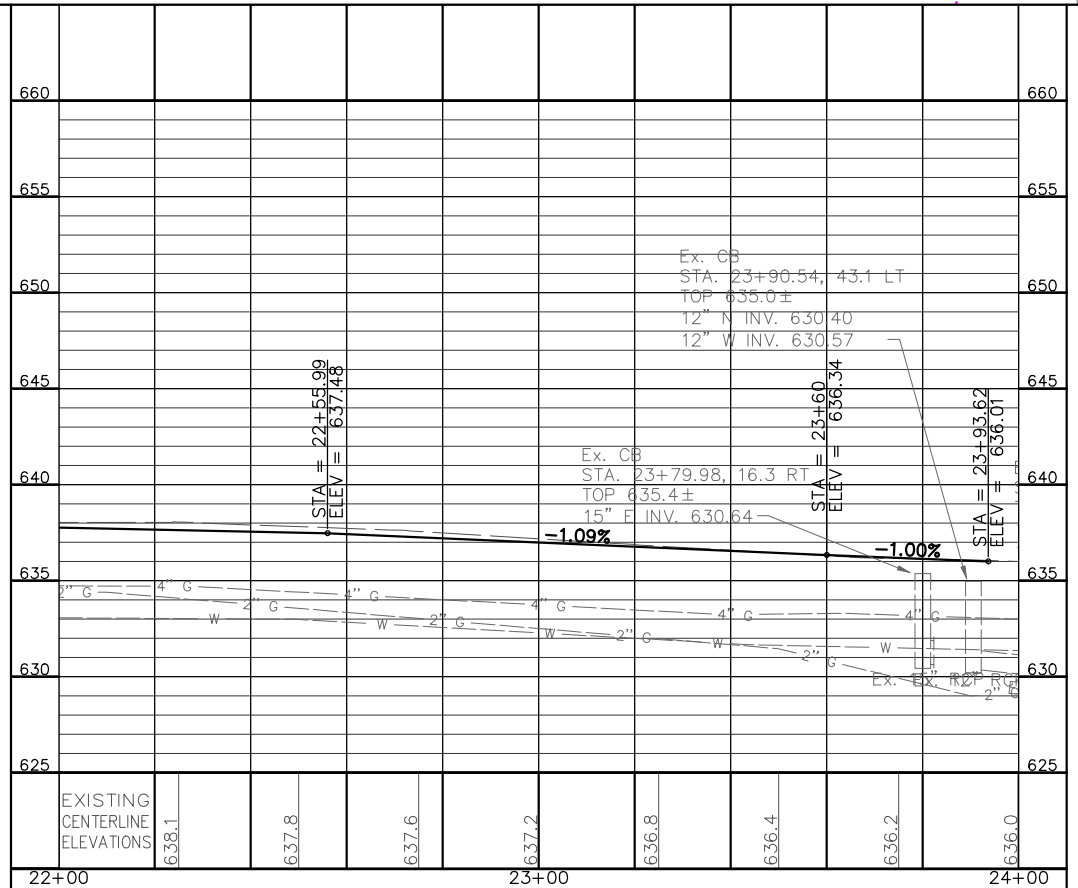
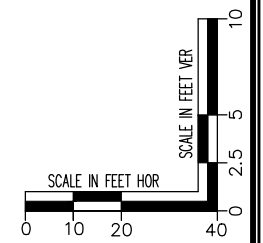
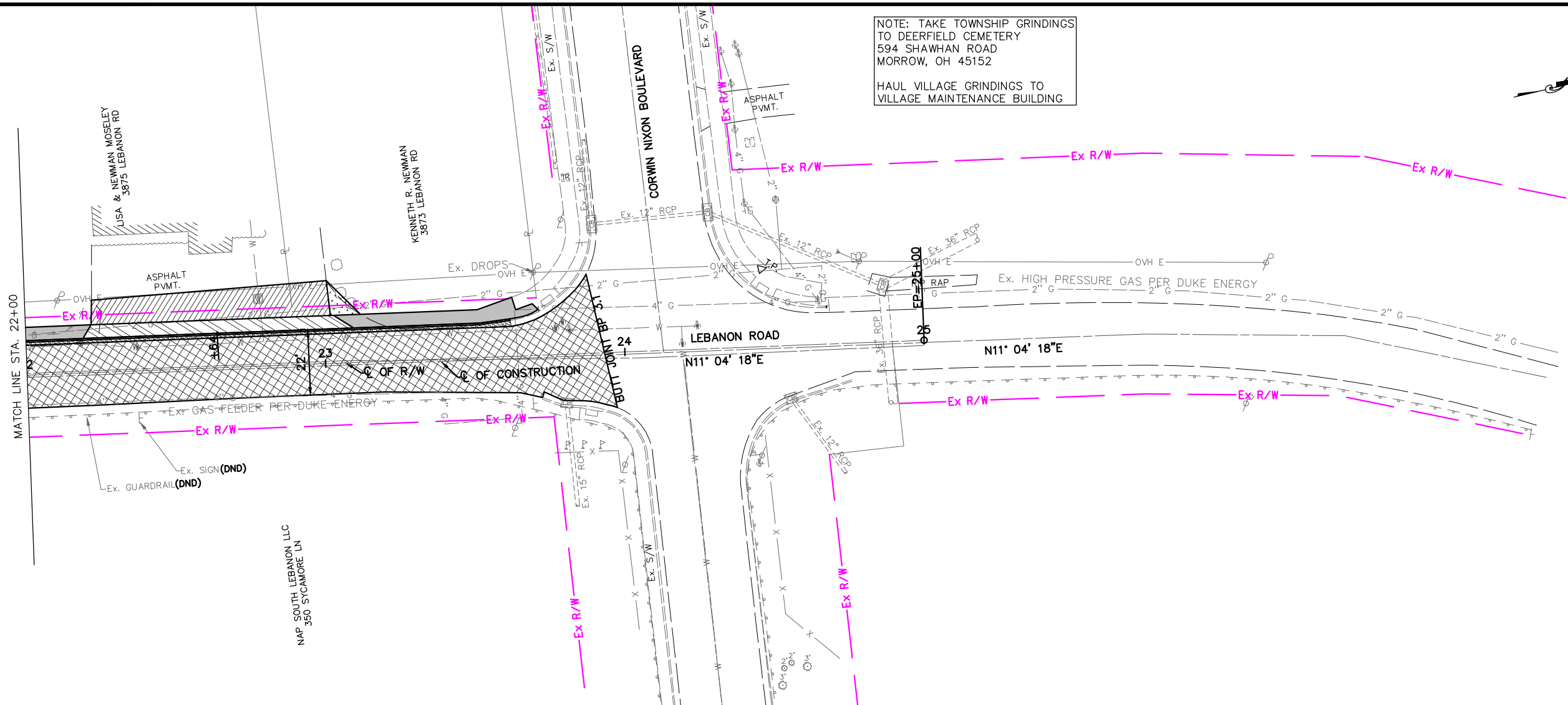

LEBANON ROAD IMPROVEMENTS
VILLAGE OF SOUTH LEBANON
LEBANON ROAD C.S. STA. 14+00 TO STA. 15+50

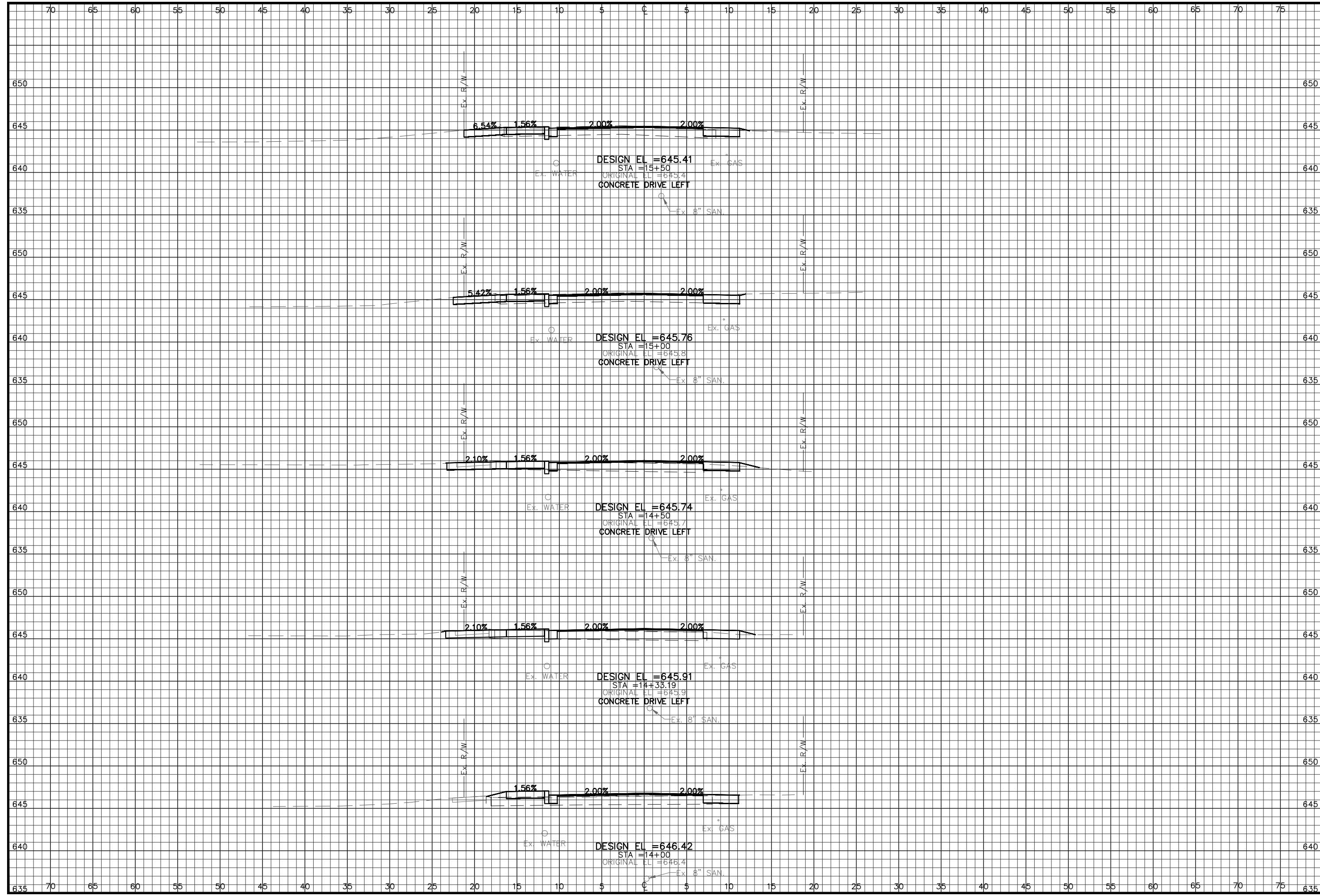

REVISIONS:

FILE NAME	C.S. (1)
DRAWN BY	JET
CHECKED BY	NNS
PROJECT No.	WARSLE2003
DATE	05-3-2021
SHEET NUMBER	13 OF 18

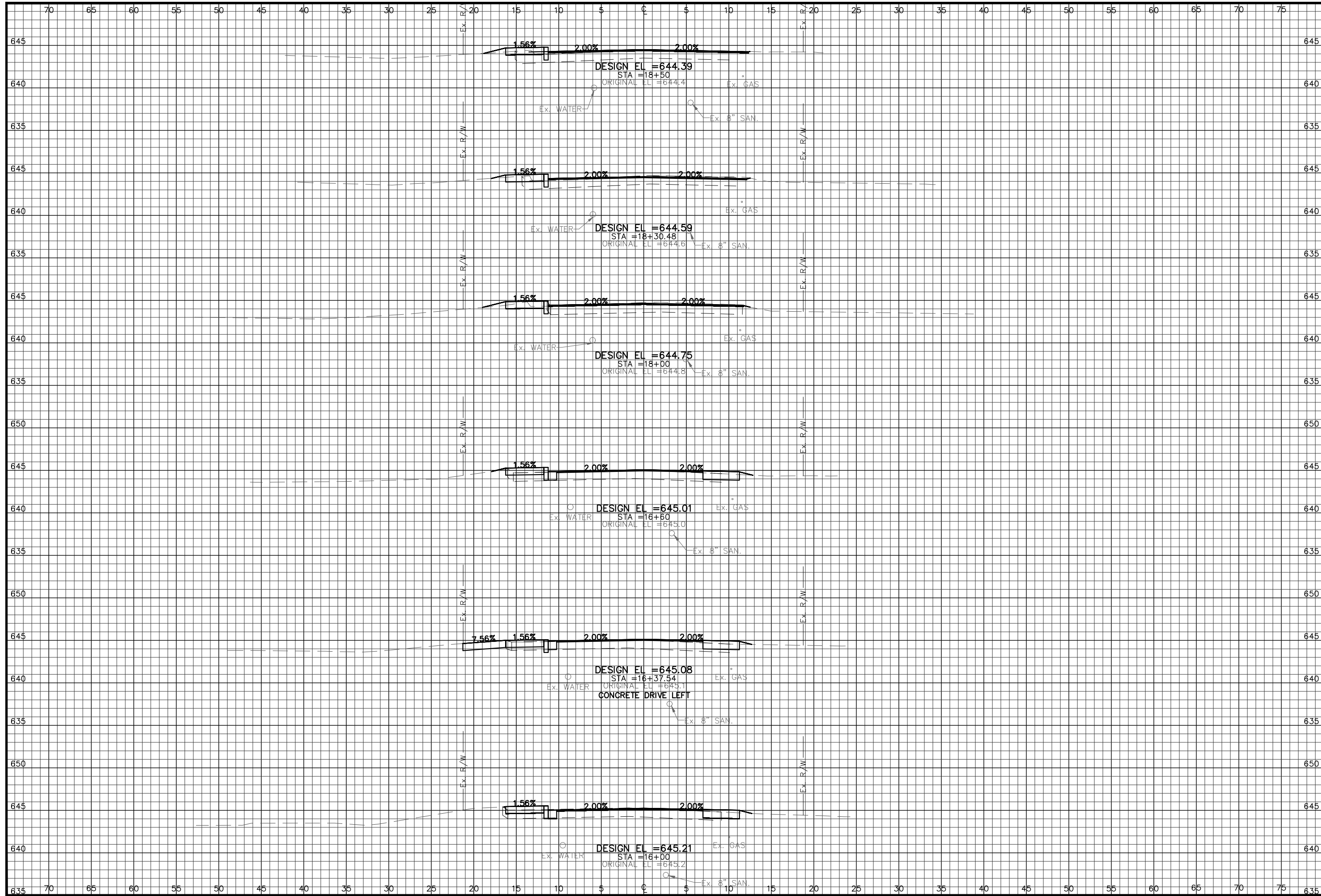

LEBANON ROAD IMPROVEMENTS
VILLAGE OF SOUTH LEBANON
LEBANON ROAD C.S. STA. 16+00 TO STA. 18+50

REVISIONS:
FILE NAME C.S. (2)
DRAWN BY JET
CHECKED BY NNS
PROJECT No. WARSLE2003
DATE 05-3-2021
SHEET NUMBER 14 OF 18

LEBANON ROAD IMPROVEMENTS
VILLAGE OF SOUTH LEBANON
LEBANON ROAD C.S. STA. 18+80.79 TO STA. 21+50

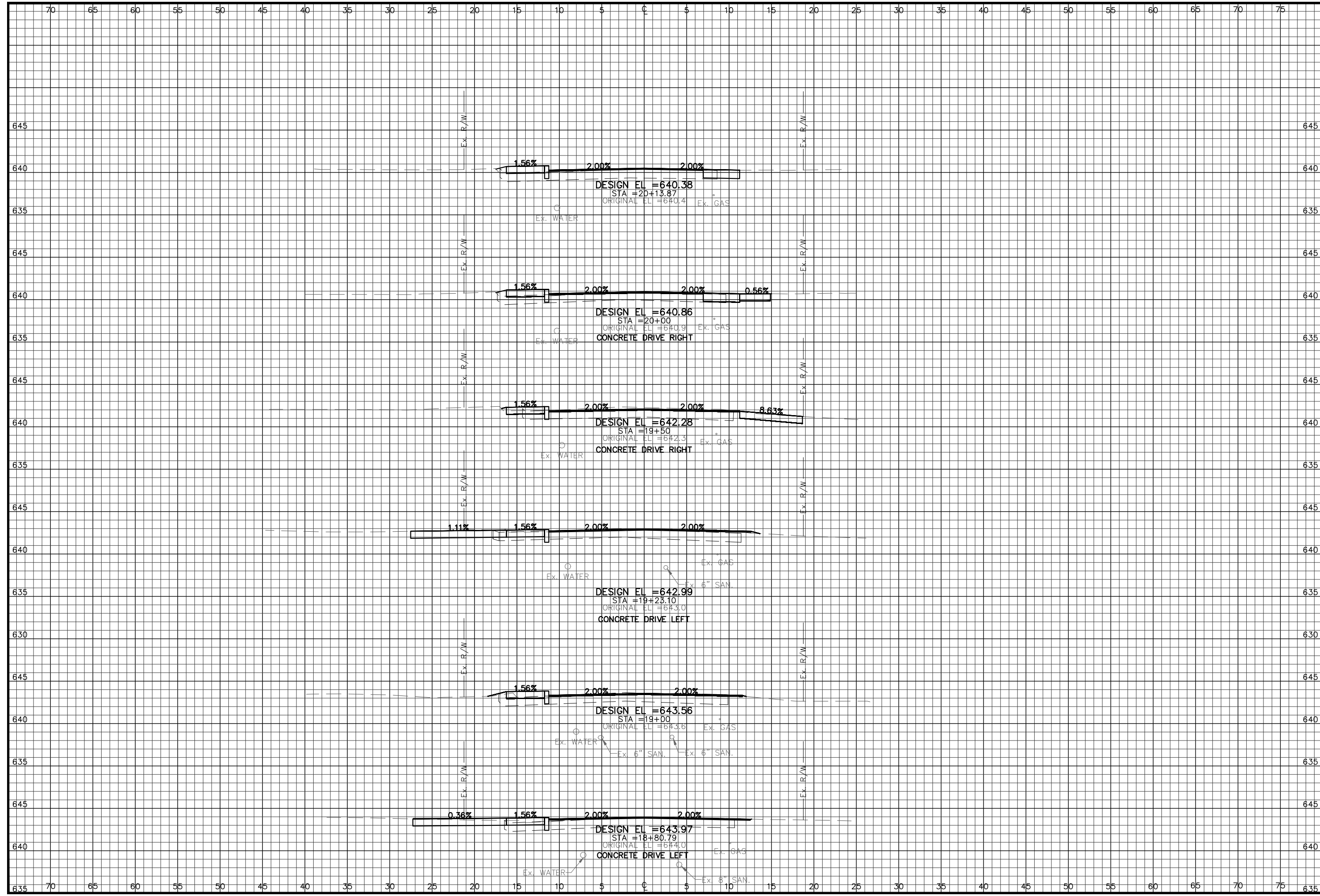

REVISIONS:

FILE NAME	C.S. (3)
DRAWN BY	JET
CHECKED BY	NNS
PROJECT No.	WARSL2003
DATE	05-3-2021
SHEET NUMBER	

**LEBANON ROAD IMPROVEMENTS
VILLAGE OF SOUTH LEBANON
LEBANON ROAD C.S. STA. 22+00 TO STA. 23+50**

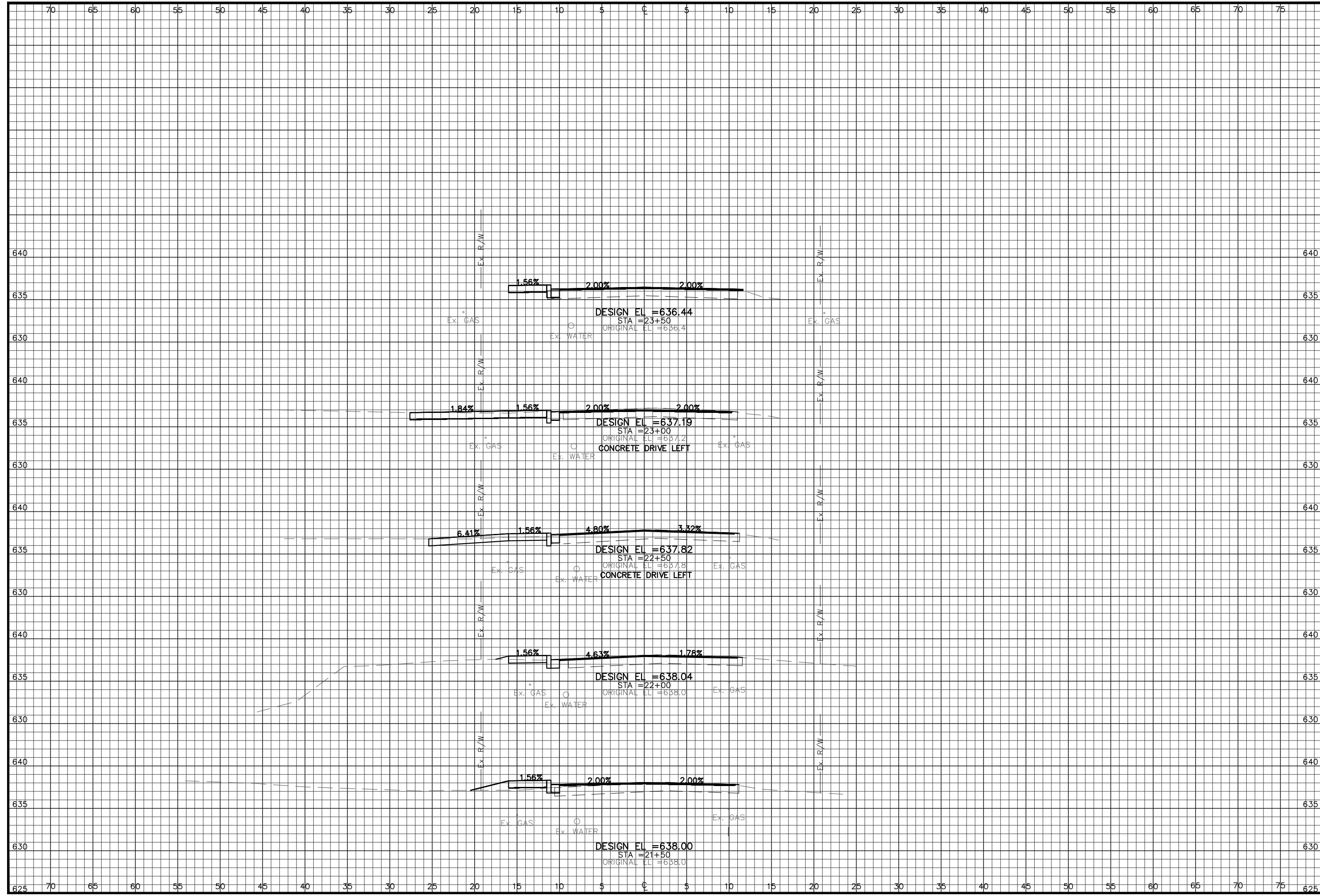

REVISIONS:

FILE NAME
C.S. (4)

DRAWN BY
JET

CHECKED BY
NNS

PROJECT No.
WARSLE2003

DATE
05-3-2021

SHEET NUMBER

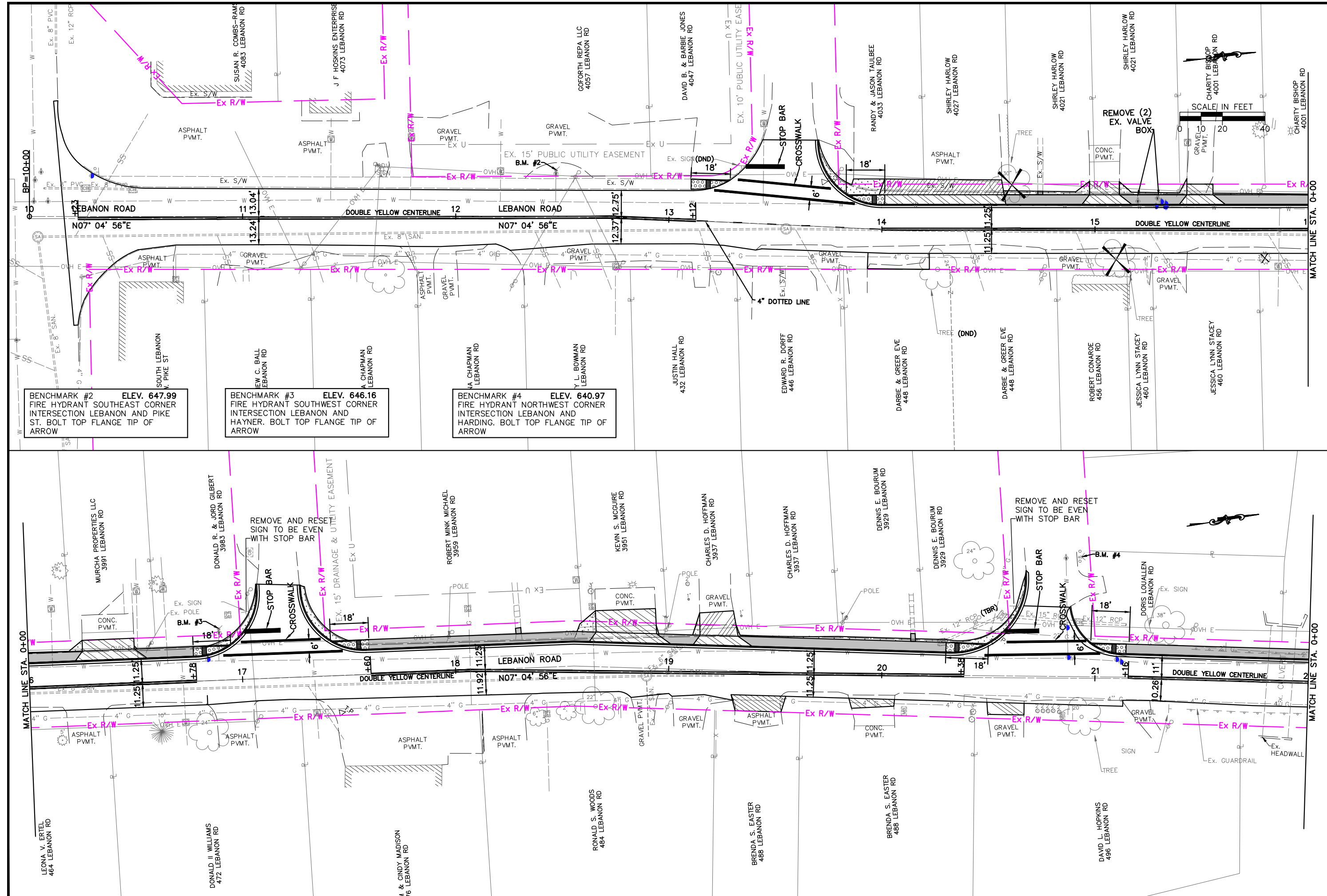

BENCHMARK #2 ELEV. 647.99
 FIRE HYDRANT SOUTHEAST CORNER
 INTERSECTION LEBANON AND PIKE
 ST. BOLT TOP FLANGE TIP OF
 ARROW

BENCHMARK #3 ELEV. 646.16
 FIRE HYDRANT SOUTHWEST CORNER
 INTERSECTION LEBANON AND
 HAYNER. BOLT TOP FLANGE TIP OF
 ARROW

BENCHMARK #4 ELEV. 640.97
 FIRE HYDRANT NORTHWEST CORNER
 INTERSECTION LEBANON AND
 HARDING. BOLT TOP FLANGE TIP OF
 ARROW

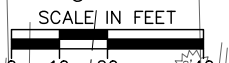

**LEBANON ROAD IMPROVEMENTS
 VILLAGE OF SOUTH LEBANON
 PAVEMENT MARKING PLAN STA. 10+00 TO STA. 22+00**

REVISIONS:
FILE NAME PAVEMENT MARKING
DRAWN BY JET
CHECKED BY NNS
PROJECT No. WARSLE2003
DATE 05-3-2021
SHEET NUMBER 17 OF 18

BID/CONTRACT DOCUMENTS
FY2020 South Lebanon / Union Township -
Lebanon Road Improvement CDBG Project

Bid Date:
Tuesday, June 1, 2021
9:30 AM

WARREN COUNTY BOARD OF COMMISSIONERS
406 JUSTICE DRIVE
LEBANON, OHIO 45036
(513) 695-1250

TABLE OF CONTENTS

- I. Bidder Identification
- II. Invitation to Bid
- III. Instructions to Bidders
- IV. Technical Specifications
- V. Proposal Forms
 - A. Bid Form and Proposal Price Sheet
 - B. Affidavit of Contractor or Supplier of Non-Delinquency of Personal Property Taxes
 - C. Bid Guaranty and Contract Bond/Performance Bond
 - D. Bonding and Insurance Requirements
 - E. Non-Collusion Affidavit
 - F. Experience Statement
 - G. List of Subcontractors
- VI. Contract
 - A. Contract
 - B. Certification
- VII. Federal and State Requirements
 - A. Conflict of Interest
 - B. Special Conditions Pertaining to Hazards, Safety Standards and Accident Prevention
 - C. Special Equal Opportunity Provisions
 - D. Contractor Section 3 Plan Format
 - E. Proposed Subcontracts Breakdown
 - F. Estimated Project Workforce Breakdown
 - G. Certification of Bidder Regarding Equal Employment Opportunity
 - H. Certification of Subcontractor Regarding Equal Employment Opportunity
 - I. Certification of Bidder Regarding Section 3 and Segregated Facilities
 - J. Certification of Proposed Subcontractor Regarding Section 3 and Segregated Facilities
 - K. Certification of Compliance with Air and Water Acts (Applicable to contracts exceeding \$100,000)
 - L. Architect's Certification of Compliance with Minimum Standards for Accessibility by the Physically Handicapped
 - M. Designer's Certification of Compliance with Minimum Standards for Accessibility by the Physically Handicapped
- VIII. Federal Labor Standards Provisions

- A. U.S. Department of Housing and Urban Development's Federal Labor Standards Provisions
- B. Certificate of Compliance with Federal Labor Standards Provisions
- C. Contractor's Certification Concerning Labor Standards and Prevailing Wage Requirements
- D. Subcontractor's Certification Concerning Labor Standards and Prevailing Wage Requirements
- E. Federal Davis-Bacon Wage Decision

IX. Prevailing Wage Information

SECTION I
BIDDER IDENTIFICATION

BIDDER IDENTIFICATION

ATTENTION BIDDER: Please fill out this form and submit with your bid.

COMPANY NAME: _____

CHIEF EXECUTIVE OFFICER: _____

ADDRESS: _____

PHONE NUMBER: _____

PROJECT CONTACT PERSON: _____

PHONE NUMBER: _____

EMAIL. _____

Warren County, Ohio

Contractor / Subcontractor MBE / WBE Information

Contractor / Subcontractor Name: _____

Address _____

City, State, Zip _____

Phone _____ Federal ID No. _____

Contract / Subcontract Amount: _____

Please provide information below regarding contractor / subcontractor's president, chief executive or owner if sole proprietorship, or all partners if partnership. (If partnership, please indicate percent of ownership).

Contractor is:

- Corporation
- Sole Proprietorship
- Partnership Percent of ownership _____

Gender:

- Male
- Female

Race:

- White American
- Black American
- Native American
- Hispanic American
- Asian/Pacific American
- Hasidic Jew

Type of Trade:

- New Construction
- Substantial Rehap
- Repair
- Service
- Project Mangt.
- Professional
- Tenant Services
- Education / Training
- Arch./Engrg Appraisal
- Other

MBE/WBE Status (check all that apply):

- MBE
- WBE

Completed by _____

Signature _____

Date _____

SECTION II
INVITATION TO BID

INVITATION TO BIDDERS

Separate sealed bids for the **FY2020 South Lebanon / Union Township – Lebanon Road Improvement CDBG Project** will be received by the Warren County Board of Commissioners at the Office of the Warren County Commissioners, 406 Justice Drive, Lebanon, Ohio 45036, until **9:30 a.m. on Tuesday, June 1, 2021** and then at said time publicly opened and read aloud.

Bid documents and specifications for **FY2020 South Lebanon / Union Township – Lebanon Road Improvement CDBG Project** may be obtained online at <https://www.co.warren.oh.us/Commissioners/Bids/Default.aspx>

Bidders MUST contact Warren County Grants Administration to be placed on the bidders list. Contact Warren County Grants Administration at susanne.mason@co.warren.oh.us or 513-695-1210.

A Bid guaranty, as required by Ohio Revised Code, Section 153.54, shall accompany each proposal submitted, as follows:

1. A Certified check, cashiers check, or letter of credit equal to ten (10) percent of the bid. A letter of credit may only be revocable by the Owner. Upon entering into a contract with the Owner, the contractor must file a performance bond for the amount of the contract, and the bid guaranty will then be returned to the successful and unsuccessful bidders upon contract execution.

OR

2. A form of bid guaranty bond (attached) for the full amount of the bid. Such bond is retained for the successful bidder, but returned to unsuccessful bidders after the contract is executed.

Bid Bonds shall be accompanied by Proof of Authority of the official or agent signing the bond.

Bids shall be sealed and marked as Bid for:

" FY2020 South Lebanon / Union Township – Lebanon Road Improvement CDBG Project"

and mailed or delivered to:

Warren County Commissioners Office
406 Justice Drive
Lebanon, Ohio 45036

Attention of bidders is called to all of the requirements contained in the bid packet, particularly to the Federal Labor Standards Provisions and Davis-Bacon Wages, various insurance requirements, various equal opportunity provisions, and the requirement for a payment bond and performance bond for 100 percent of the contract price.

No bidder may withdraw his bid within sixty (60) days after the actual date of the opening thereof.

All bids shall be properly signed by an authorized representative of the bidder.

Warren County reserves the right to reject any or all bids submitted, to waive any irregularities in bids, and enter into a contract with the Bidder who in Warren County's consideration offered the lowest and best bid.

Any questions may be directed to Susanne Mason at the Warren County Office of Grants Administration at (513) 695-1210.

SECTION III
INSTRUCTIONS TO BIDDERS

INSTRUCTIONS TO BIDDERS

1. Receipt and Opening of Bids:

The Warren County Board of Commissioners (herein referred to as "Owner"), invites bids on the form attached hereto, all blanks of which must be appropriately filled in. Bids will be received by the Owner at the Office of the Warren County Board of Commissioners until **9:30 a.m. on Tuesday, June 1, 2021**, and then at said office publicly opened and read aloud. The envelopes containing the bids must be sealed, addressed to Warren County Board of Commissioners at 406 Justice Drive, Lebanon, Ohio 45036. Bids shall be submitted in a sealed envelope clearly marked **"FY2020 South Lebanon / Union Township – Lebanon Road Improvement CDBG Project."** The Owner may consider informal any bid not prepared and submitted in accordance with the provisions hereof and may waive any informalities or reject any and all bids. Any bid may be withdrawn prior to the above scheduled time for the opening of bids or authorized postponement thereof. Any bid received after the time and date specified shall not be considered. No bidder may withdraw a bid within 60 days after the actual date of the opening thereof.

2. Preparation of Bid:

Each bid must be submitted on the prescribed form and such documents as hereunder described. All blank spaces for bid prices must be filled in, in ink or typewritten, in both words and figures, and the foregoing certifications must be fully completed and executed when submitted.

3. Method of Bidding:

Bids shall be submitted at the time and place indicated in the Invitation to Bidder and shall be included in a sealed envelope, marked with the project title and name and address of the bidder and accompanied by the bid security and other required documents.

Bids may be modified or withdrawn by an appropriate document duly executed (in the manner that a bid must be executed) and delivered to the place where bids are to be submitted at any time prior to the opening of bids.

The Owner invites unit price bids for the construction described in the plans and specifications. These unit prices shall be extended by estimated quantities to develop a total price for the project.

If the total price received from the lowest and best bidder exceeds the amount of funds available to finance the contract, the Owner may:

- a. Reject all bids;
- b. Augment the funds available in an amount sufficient to enable award to the lowest and best bidder or bidders;

- c. Reduce the scope of work by eliminating certain items of work to produce a total bid which is within available funds;
- d. Reduce the scope of work by reducing the quantity of certain items of work to produce a total bid which is within available funds;
- e. Reduce the scope of work by a combination of adjustments as outlined in "c" and "d" above to produce a total bid which is within available funds.

The engineer's estimate on this project is **\$234,508.00**.

4. Qualifications of Bidder:

The Owner may make such investigations as he/she deems necessary to determine the ability of the bidder to perform the work, and the bidder shall furnish to the Owner all such information and data for this purpose as the Owner may request. The Owner reserves the right to reject any bid if the evidence submitted by, or investigation of, such bidder fails to satisfy the Owner that such bidder is properly qualified to carry out the obligations of the contract and to complete the work contemplated therein. Conditional bids will not be accepted.

5. Bid Security:

Each bid must be accompanied by cash, certified check of the bidder, or a bid bond prepared on the form of bid bond attached hereto, duly executed by the bidder as principal and having as surety thereon a surety company approved by the Owner. (See Invitation to Bidders for required amounts) Such cash, checks or bid bonds will be returned to bidders after the Owner has awarded the bid and has executed the contract, or, if no award has been made within 60 days after the date of the opening of bids, upon demand of the bidder at any time thereafter, so long as he/she has not been notified of the acceptance of his/her bid.

6. Liquidated Damages for Failure to Enter into Contract:

The successful bidder, upon his/her failure or refusal to execute and deliver the contract and bonds required within 10 days after he/she has received notice of the acceptance of his/her bid, shall forfeit to the Owner, as liquidated damages for such failure or refusal, the security deposited with his/her bid.

7. Time of Completion and Liquidated Damages:

Bidder must agree to commence work on or before a date to be specified in a written "Notice to Proceed" by the Owner and to fully complete the project **by November 18, 2021**. The completion date may not be extended, even in the event of adverse weather conditions. Bidder must agree also to pay as liquidated damages, the sum of \$100.00 for each consecutive calendar day thereafter.

8. Conditions of Work:

Each bidder must inform him/herself fully of the conditions relating to the construction of the project and the employment of labor thereon. Failure to do so will not relieve a successful bidder of his/her obligation to furnish all material and labor necessary to carry out the provisions of his/her contract. Insofar as possible the contractor, in carrying out the work, must employ such methods or means or will not cause any interruption of or interference with the work of any other contractor.

9. Addenda and Interpretations:

No interpretation of the meaning of the plans, specifications or other pre-bid documents will be made to any bidder orally. Every request for such interpretation must be in writing and addressed to: Susanne Mason, Grants Coordinator, Office of Grants Administration, 406 Justice Drive, Lebanon, Ohio 45036, and to be given consideration must be received at least five days prior to the date fixed for the opening of bids. All such interpretations and any supplemental instructions will be in the form of written addenda to the specifications which, if issued, will be mailed by certified mail with return receipt requested to all prospective bidders (at the respective addresses furnished for such purposes), no later than three days prior to the date fixed for the opening of bids. Failure of any bidder to receive any such addendum or interpretations shall not relieve such bidder from any obligation under his/her bid as submitted. All addenda so issued shall become part of the contract documents.

10. Security for Faithful Performance:

Simultaneously with his/her delivery of the executed contract, the Contractor shall furnish a performance (surety) bond as security for faithful performance of this contract and for the payment of all persons performing labor on the project under the contract and furnishing materials in connection with the contract. The surety on such bond or bonds shall be a duly authorized surety company satisfactory to the Owner. Please note that upon execution of the Contract if a Bid Guaranty/ Contract Bond was submitted with your original bid a Performance Bond will not be required.

11. Power of Attorney:

Attorneys-in-fact who sign bid bonds or contract bonds must file with each bond a certified and effectively dated copy of their power of attorney.

12. Laws and Regulations:

The bidder's attention is directed to the fact that all applicable State laws, municipal ordinances, and the rules and regulations of all authorities having jurisdiction over construction of the project shall apply to the contract throughout, and they will be deemed to be included in the contract the same as though herein written out in full.

13. Method of Award - Lowest Qualified Bidder:

The Owner may reject all bids or may award the contract on the base bid or on the base bid combined with additions or deductible alternates as produces a net amount which is within the available funds.

14. Obligation of Bidder:

At the time of the opening of bids each bidder will be presumed to have inspected the site and to have read and to be thoroughly familiar with the plans and contract documents (including all addenda). The failure or omission of any bidder to examine any form, instrument or document shall in no way relieve any bidder from any obligation in respect of his/her bid.

15. Safety Standards and Accident Prevention:

With respect to all work performed under this contract, the Contractor shall:

- a. Comply with the safety standards provisions of applicable laws, building and construction codes and the "Manual of Accident Prevention in Construction" published by the Associated General Contractors of America, the requirements of the Occupational Safety and Health Act of 1970 (Public Law 91-596), and the requirements of title 29 of the code of Federal Regulations, Section 1518 as published in the "Federal Register", Volume 36, N. 75, Saturday, April 17, 1971.
- b. Exercise every precaution at all times for the prevention of accidents and the protection of persons (including employees) and property.
- c. Maintain at his/her office or other well known place at the job site, all articles necessary for giving first aid to the injured, and shall make standing arrangements for the immediate removal to a hospital or doctor's care of persons (including employees) who may be injured at the job site. In no case shall employees be permitted to work at a job site before the employer has made a standing arrangement for removal of injured persons to a hospital or doctor's care.

16. Examination of Site:

Each bidder shall, and is hereby directed to inspect the entire site of the proposed work and judge for him/herself as to all the circumstances affecting the cost and progress of the work and shall assume all patent and latent risks in connection therewith.

17. Soil Conditions:

Subject to the convenience of the Owner, prospective bidders will be permitted to explore the site by making borings or digging test pits. In such event, the work shall be done at the sole expense and risk of the bidder, and he/she shall maintain and restore the site to original condition. The Owner does not guarantee the accuracy of any information or samples which it may have obtained from test borings or otherwise as to the kind or condition of the soil that may be encountered in the prosecution of the proposed work, neither does the Owner represent that the plans and specifications drawn are based upon any data so obtained. The Owner does not make any representation as to the soil which may be encountered or of soil or water which underlies the work or is adjacent thereto, including any difficulties that may be due to quicksand, or other unfavorable conditions that may be encountered in the work, whether apparent upon surface inspection or disclosed in the process of carrying forward the work.

18. Water Supply:

All water for construction purposes, as well as the expense of having water conveyed about the work, must be provided by the Contractor and the cost of this work shall be included in the unit prices stipulated for the various items of the work to be done under this contract.

19. Working Facilities:

The plans show, in the general manner, the existing structures and the land available for construction purposes. The bidders must satisfy themselves of the conditions and difficulties that may be encountered in the execution of the work at this site.

20. Permits:

The Contractor shall take out all necessary permits from the proper authorities, and shall give all notices required by law or ordinance. The charge or fee for any permit issued by the proper authority shall be borne by the contractor.

21. Signature of Bidders:

The firm, corporate or individual name of the bidder must be signed in ink in the space provided for the signatures on the proposed blanks. In the case of a corporation, the title of the officer signing must be stated and such officer must be thereunto duly authorized and the seal of said corporation duly affixed. In the case of a partnership, the signature of at least one of the partners must follow the firm name, using the term "member of the firm." In the case of an individual, use the terms "doing business as", or "sole owner." The bidder shall further state in his proposal the name and address of each person or corporation interested therein.

22. Right to Accept or Reject Proposals:

The Owner may consider informal and may reject any bid not prepared and submitted in accordance with the provisions hereof. The Owner reserves the right to reject all bids, to waive any informalities or irregularities in the bids received, and to accept any bid which is deemed most responsive and responsible.

23. Non-Collusion Affidavit:

The successful bidder will be required to submit a non-collusion affidavit on the form included in these Bid/Contract documents (Section V). This affidavit shall be dated and executed as part of this bid.

24. Wage Rates:

In the event that the rate of wages paid for any trade or occupant in the locality where such work is being performed are under current collective agreements or understandings between bona fide organizations of labor and employer, then the wages to be paid shall be not less than such agreed wage rates, nor less than the minimum rates compiled by the Federal Labor Standard Act. A copy of these prevailing wage rates have been included in these specifications. Every Contractor and Subcontractor who is subject to Ohio Revised Code, Chapter 4115 shall, as soon as he begins performance under his contract with the Owner, supply the Prevailing Wage Coordinator for the Owner a schedule of the dates on which he is required to pay wages to employees. He shall also deliver to the Prevailing Wage Coordinator within three weeks after each pay date, a certified copy of his payroll which shall exhibit for each employee paid any wages, name, current address, social security number, number of hours worked each day of the pay period and the total for each week, hourly rate of pay, job classification, fringe payments, and deductions from wages. The certification of each payroll shall be executed by the Contractor, Subcontractor, or duly appointed agent thereof and shall recite that the payroll is correct and complete and that the wage rate shown is not less than those required by the contract.

In case the Owner orders the Contractor to perform extra or additional work which may make it necessary for the Contractor or any Subcontractor under this contract to employ a person not herein specified, the Owner will include in the contract change order for such extra or additional work, a minimum wage rate for such trade or occupation, and insofar as such extra or additional work is concerned, there shall be paid to each employee engaged in work of such trade or occupation, not less than the wage so included. Insofar as possible, local labor shall be employed on this work.

25. Subletting of Contract:

The Contractor shall not sublet, sell, transfer or assign any portion of the contract without written consent of the Owner or his designated agent. When such consent is given, the Contractor will be permitted to sublet a portion thereof, but shall perform with his own organization, work amounting to no less than fifty percent of the total contract cost, except that any time designated in the contract before computing the amount of work required to be performed by the Contractor with his own organization, No subcontract, or transfer of contract, shall in any way release the Contractor of his liability under the contract and bonds.

26. Required Insurance:

In accordance with the specifications, the Contractor, without restricting the obligations and liabilities assumed under the Contract Documents, shall at his own cost and expense purchase and maintaining in force until final acceptance of his work, the forms of insurance coverage listed below.

Certificates from the insurance carrier stating the limits of liability and expiration date shall be filed with the Owner before operations are begun. Such certificates shall not merely name the types of policy provided, **but shall specifically refer to this Contract** and shall name the Board of Warren County Commissioners as additionally insured. However, the original policy for Owner's Protective Bodily Injury (Item F) and Property Damages (Item G) shall at this time be delivered to the Owner for its possession.

All policies as hereinafter required shall be so written that the Owner will be notified of cancellation or restrictive amendment at least ten days prior to the effective date of such cancellation or amendment.

Item A - Workmen's Compensation and/or Employer's liability Insurance as required or specified by State Law.

Item B - Contractor's Direct and Completed Operations Bodily Injury Liability Insurance.

Item C - Contractor's Direct and Completed Operations Property Damage Liability Insurance.

III-7

Item D - Contractor's Protective Bodily Injury Liability Insurance.

Item E - Contractor's Protective Damage Liability Insurance.

Item F - Owner's Protective Bodily Injury Liability Insurance, naming the Owner as insured.

Item G - Owner's Protective Property Damage Liability Insurance, naming the Owner as insured.

Item H - Bodily Injury Liability Insurance covering motor vehicles either owned by the Contractor or being used in connection with the prosecution of the work embraced under this contract.

Item I - Property Damage Liability Insurance covering motor vehicles either owned by the Contractor or being used in connection with the prosecution of the work embraced under this contract.

Item J - Such Protective (including Railroad Protective) and Contractual Bodily Injury Liability Insurance and such Protective (including Railroad Protective) and Contractual Property Damage Liability Insurance as shall be required by the railroad and other utility companies whose property, facilities or rights-of-way may be affected by the work to be done under this contract, in such amounts and in such form as each such utility company may require.

If any part of the work is sublet, insurance of the same types and limits as required by above items numbered A, B, C, D, E, H, and I shall be provided by or on behalf of the Subcontractors to cover that part of the work they have contracted to perform including Property Damage Liability Special Hazards coverage if so required by this contract.

Protective and Contractual Bodily Injury Liability Insurance required by Item J shall be in an amount and form as each railroad or utility company may require.

All Bodily Injury coverage (Items B, D, F, and H) shall be broadened by the inclusion of the terms "occurrence" in lieu of "caused by accident."

In addition to the Contractor's Direct Bodily Injury Liability Insurance (Item B) and the Contractor's Direct Property Damage Liability Insurance (Item C), the Contractor shall also provide Completed Operations Bodily Injury Liability Insurance and Completed Operations Property.

Damage Liability Insurance for the same amounts as provided for Item B and C during the period of one (1) year after the final acceptance date shall be the date the final estimate is paid to the Contractors. Performance Bond includes material and workmanship for 12 months after completion.

Comprehensive General Liability Insurance: In an amount not less than \$1,000,000.00 per occurrence for Bodily Injury and \$500,000.00 for explosion underground and collapse, commonly known as "XCU."

Comprehensive Automobile Liability Insurance: In an amount not less than \$500,000.00 per person, \$1,000,000.00 per occurrence for Bodily Injury, and \$500,000.00 for Property Damage. Such coverage shall include all vehicles, owned, non-owned and hired.

Builders Risk Insurance: All Risk form, including subsidence and theft of materials from the job site. Such coverage shall be maintained until final acceptance of the Contract by the Owner and payable to the Owner for the benefit of the contractor. The limit for Builders Risk shall be the full value of construction.

27. Maintenance of Rights-of-Way:

All construction as proposed along all City, Township, County, State and Federal roads including storage and stockpiling of materials, is to be conducted within the limits of the public right-of-way. Bracing sheeting and shoring shall be used to keep all construction work within the construction limits unless work agreements are secured from the adjacent property Owners. It is the Contractor's responsibility to secure these work agreements, if deemed necessary. Copies of the work agreements shall be delivered to the Engineer and Owner prior to any work beginning on the affected property.

28. Lights, Signs and Barricades:

Lights, signs and barricades shall be used to maintain traffic and safety for vehicular and pedestrian traffic during the course of this contract and shall be the sole responsibility of the Contractor.

29. Foreign Corporation and Contractors:

Foreign Corporations

Definition: "Foreign Corporation" means a corporation incorporated under the laws of another state. No contract shall be entered into with a foreign corporation until the Secretary of State has certified that such corporation is authorized to do business in Ohio; and until, if the bidder so awarded the Contract is a person or partnership, it has filed with the Secretary of State a Power of Attorney designating the Secretary of State as its agent for the purpose of accepting service of summons in any action brought under Ohio Revised Code, Section 153.05 or under Sections 4123.01 to 4123.94, inclusive.

30. Subcontracts

Contractor shall provide an explanation as part of its bid package of all subcontractors intended to be used in performance of the work described in the Section IV. In the event the Owner does not object, Contractor may have such work performed by a subcontractor. Contractor shall bind every subcontractor to, and every subcontractor must agree to be bound by the terms of the Agreement, as far as applicable to the subcontractor's work particularly pertaining to Prevailing Wages and EEO requirements. Nothing contained in the Agreement shall create any contractual relationship between any subcontractor and Owner, nor create any obligations on the part of the Owner to pay or see to the payment of any sums to any subcontractor.

31. Personal Property Tax Affidavit

All bidders must complete the personal property tax affidavit and submit with your bid. *This section should be completed whether or not you as a vendor/contractor own property in Warren County.*

32. Description of Project:

See Section IV

33. Scope of Work:

Provide all work as described in the Specifications herein (Section IV) as necessary to provide for project completion.

34. Required Forms:

Each Bidder shall complete and submit the following forms with his/her bid:

- a. Bid Form and Proposal Price Sheet (Section V)
- b. Affidavit of Non-Delinquency of Taxes (Section V)
- c. Bid Guaranty and Contract Bond (Section V)
- d. Non-collusion Affidavit (Section V)
- e. Experience Statement (Section V)
- f. List of Subcontractors (Section V)

35. Additional Obligations Upon Contract Award:

Upon award of the bid but prior to execution of the final agreement and notice to proceed, the Contractor shall submit all of the following documents, completed as required:

- a. Acceptance of Notice of Award
- b. Contract
- c. Insurance certificate(s) and/or policy (ies)
- d. Performance Bond
- e. Contractor's Section 3 Plan (if over \$10,000)
- f. Certification of Bidder Regarding EEO (if over \$10,000)
- g. Certification(s) by any/all proposed subcontractors regarding EEO (if over \$10,000)
- h. Certification of Bidder Regarding Section 3 and Segregated Facilities
- i. Certification(s) of any/all proposed subcontractors regarding Section 3 and Segregated Facilities
- j. Certification by Contractor and Subcontractor(s) of compliance with Air and Water Acts (if over \$100,000)
- k. Contractor's Certification Concerning Labor Standards and Prevailing Wage Requirements
- l. (All) Subcontractor's Certification(s) concerning Labor Standards and Prevailing Wage Requirements
- m. Architect's or Designer's Certification of Compliance with Minimum Standards for Accessibility by the Physically Handicapped (if applicable).

36. Entire bid packet must be completed (except contract - Section VII-A) and returned with bid proposal, as the entire bid packet becomes part of the contract documents.

SECTION IV

TECHNICAL SPECIFICATIONS

Please refer to project plan set and ODOT (Ohio Department of Transportation) specifications for technical specifications.

SECTION V
PROPOSAL FORMS

BID FOR UNIT PRICE CONTRACTS

Place: 406 Justice Drive, Lebanon, OH 45036

Date: 9:30 a.m. on Tuesday, June 1, 2021

Proposal of _____(hereinafter called "Bidder", a corporation, organized and existing under the laws of the State of _____, a partnership, or an individual doing business as _____.

To the Warren County Board of Commissioners (hereinafter called "Owner")

Ladies/Gentlemen:

The Bidder, in compliance with your invitation for bids for the **FY2020 South Lebanon / Union Township – Lebanon Road Improvement CDBG Project**, having examined the plans and specifications with related documents and the site of the proposed work, and being familiar with all of the conditions surrounding the construction of the proposed project including the availability of materials and labor, hereby proposes to furnish all labor, materials, and supplies, and to construct the project in accordance with the contract documents, within the time set forth therein, and at the prices stated below. These prices are to cover all expenses incurred in performing the work required under the contract documents, of which this proposal is a part.

Bidder hereby agrees to commence work under this contract on or before a date to be specified in a written "Notice to Proceed" of the Owner and to fully complete the project within sixty (60) days from the date of said notice, as stipulated in the specifications. Bidder further agrees to pay as liquidated damages, the sum of \$100.00 per day for each consecutive calendar day thereafter as hereinafter provided in Paragraph 7 of the Instruction to Bidders.

Bidder acknowledges receipt of the following addendum:

Bidder agrees to perform all the work described in the specifications and shown on the plans, for the following unit prices shown on the Proposal Price Sheet (attached - Section V), for a total combined price of \$_____.

The unit prices shall include all labor, materials, bailing, shoring, removal, overhead, profit, insurance, etc., to cover the finished work of the several kinds called for.

Bidder understands that the Owner reserves the right to reject any or all bids and to waive any informalities in the bidding.

The bidder agrees that this bid shall be good and may not be withdrawn for a period of 60 calendar days after the scheduled closing time for receiving bids.

Upon receipt of written notice of the acceptance of this bid, bidder will execute the formal contract attached within 10 days and deliver a Surety Bond or Bonds as required by Paragraph 5 of Instructions to Bidders. The bid security attached in the sum of _____

_____ Dollars (\$ _____) is to become the property of the Owner in the event the contract and bond are not executed within the time above set forth, as liquidated damages for the delay and additional expense to the Owner caused thereby.

(Seal-if bid is
by a corporation)

Respectfully submitted:

By _____

(Business Address and Zip Code)

FY2020 South Lebanon / Union Township – Lebanon Road Improvement CDBG Project

Name: _____

Bid page 1 of 2

ITEM NO.	ITEM NO.	DESCRIPTION	UNIT OF MEASURE	APPROX. QTY.	UNIT PRICE	TOTAL
1	201	CLEARING AND GRUBBING	LUMP	1		
2	202	REMOVED, AS PER PLAN	LUMP	1		
3	202	CURB REMOVED	FT.	738		
4	202	WALK REMOVED	S.F.	450		
5	202	PIPE REMOVED, 24" AND UNDER	FT.	31		
6	202	VALVE BOX REMOVED	EACH	2		
7	202	CATCH BASIN REMOVED	EACH	1		
8	203	EXCAVATION (INCLUDES ASPHALT PAVEMENT REMOVAL)	C.Y.	120		
9	204	SUBGRADE COMPACTION	S.Y.	354		
10	253	FULL-DEPTH PAVEMENT REPAIR CONTINGENCY	S.Y.	75		
11	254	1-1/2"± PAVEMENT PLANING, ASPHALT CONCRETE	S.Y.	3665		
12	301	9" ASPHALT CONCRETE BASE, PG64-22	C.Y.	89		
13	301	4" ASPHALT CONCRETE BASE, PG64-22 (DRIVEWAYS)	C.Y.	17		
14	304	4" AGGREGATE BASE (SIDEWALK AND CURB RAMPS)	C.Y.	35		
15	304	AGGREGATE BASE (DRIVEWAYS)	C.Y.	42		
16	407	NON-TRACKING TACK COAT, 0.09 GAL/S.Y.	GAL.	362		
17	441	ASPHALT CONCRETE INTERMEDIATE COURSE, TYPE 1, (448)	C.Y.	30		
18	441	1-1/2" ASPHALT CONCRETE SURFACE COURSE, TYPE 1, PG 64-22	C.Y.	168		
19	441	2" ASPHALT CONCRETE SURFACE COURSE, TYPE 1, (448) PG64-22 (DRIVEWAYS)	C.Y.	8		
20	452	6" NON-REINFORCED CONCRETE PAVEMENT, AS PER PLAN	S.Y.	190		
21	606	GUARDRAIL REMOVED AND REBUILT	FT.	75		
22	608	4" CONCRETE WALK, AS PER PLAN	S.F.	2467		
23	608	CURB RAMP	S.F.	360		
24	609	TYPE 6 BARRIER CURB, AS PER PLAN	FT.	1027		
25	611	4" CONDUIT, TYPE B, 707.45, STORM REPAIR	FT.	10		
26	611	6" CONDUIT, TYPE B, 707.45, STORM REPAIR	FT.	10		
27	611	8" CONDUIT, TYPE B, 707.45, STORM REPAIR	FT.	10		
28	611	12" RCP CL IV STORM SEWER, AS PER PLAN	FT.	69		
29	611	TYPE 3A CATCH BASIN	EACH	2		
30	611	TYPE 2-2B CATCH BASIN	EACH	1		
31	611	CATCH BASIN RECONSTRUCTED TO GRADE	EACH	1		
32	611	MANHOLE ADJUSTED TO GRADE	EACH	2		

Name: _____

ITEM NO.	ITEM NO.	DESCRIPTION	UNIT OF MEASURE	APPROX. QTY.	UNIT PRICE	TOTAL
33	614	MAINTAINING TRAFFIC	LUMP	1		
34	614	DETOUR SIGNING	LUMP	1		
35	623	CONSTRUCTION LAYOUT STAKES AND SURVEYING, AS PER PLAN	LUMP	1		
36	630	REMOVAL OF GROUND MOUNTED SIGN/POST AND REERECTION	EACH	2		
37	638	VALVE BOX ADJUSTED TO GRADE	EACH	9		
38	644	CENTER LINE	MILE	0.25		
39	644	STOP LINE	FT.	52		
40	644	CROSSWALK LINE	FT.	294		
41	644	4" DOTTED LINE	FT.	86		
42	659	SEEDING AND MULCHING, TYPE 1, AS PER PLAN	S.Y.	1250		
		TOTAL				

BID PROPOSAL

Proposal for the **FY2020 South Lebanon / Union Township – Lebanon Road Improvement CDBG Project**. The project shall be as per plans and specifications as provided by the Warren County Engineer.

The undersigned do hereby propose to furnish all labor, material, tools, equipment, etc., necessary to complete the paving on roads located in Warren County, Ohio.

TOTAL BID PRICE \$ _____

The above quotations to be in full force and effect for sixty (60) days after the date of opening bids. The contract will be awarded to the best and most responsive bid based on the qualifications of the Contractor and the total price of the **TOTAL BID PRICE**. The full name and address of all persons and parties interested in the foregoing bids as principals are as follows:

SIGNED

NAME

COMPANY

TITLE

ADDRESS

DATE

EXCEPTION SHEET

Exceptions: Exceptions to any bid specification must be clearly stated on this sheet. This sheet must be submitted with each bid. If there are no exceptions, please indicate "none" below.

- 1) _____
- 2) _____
- 3) _____
- 4) _____
- 5) _____
- 6) _____
- 7) _____
- 8) _____
- 9) _____
- 10) _____

BID GUARANTY AND CONTRACT BOND

KNOW ALL MEN BY THESE PRESENTS, that we, the undersigned,

(Insert full name or legal title of Contractor and Address)

as Principal and _____

(Insert full name or legal title of Surety)

as Surety, are hereby held and firmly bound unto the Warren County Board of Commissioners hereinafter called the Obligee, in the penal sum of the dollar amount of the bid submitted by the Principal to the Obligee on _____ to undertake the project known as:

FY2020 South Lebanon / Union Township – Lebanon Road Improvement CDBG Project

The penal sum referred to herein shall be the dollar amount of the Principal's bid to the Obligee, incorporating any additive or deductive alternate proposals made by the Principal on the date referred to above to the Obligee, which are accepted by the Obligee. In no case shall the penal sum exceed the amount of _____ DOLLARS, \$ _____.

If this item is left blank, the penal sum will be the full amount of the Principal's bid, including alternates. Alternatively, if completed, the amount stated must not be less than the full amount of the bid, including alternates in dollars and cents. A percentage is not acceptable.

For the payment of the penal sum well and truly to be made we hereby jointly and severally bind ourselves, our heirs, executors, administrators, successors, and assigns.

THE CONDITION OF THE ABOVE OBLIGATION IS SUCH, that whereas the above named Principal has submitted a bid on the above referred to project;

NOW, THEREFORE, if the Obligee accepts the bid of the Principal and the Principal fails to enter into a proper contract in accordance with the bid, plans, details, specifications, and bills of material; and in the event the Principal pays to the Obligee the difference not to exceed ten percent of the penalty hereof between the amount specified in the bid and such larger amount for which the Obligee may in good faith contract with the next lowest bidder to perform the work covered by the bid; or in the event the Obligee does not award the contract to the next lowest bidder and resubmits the project for bidding, the Principal will pay the Obligee the difference not to exceed ten percent of the penalty hereof between the amount specified in the bid, or the costs, in connection with the resubmission, of printing new contract documents, required advertising, and printing and mailing notices to prospective bidders, whichever is less, then this obligation shall be null and void, otherwise to remain in full force and effect. If the Obligee accepts the bid of the Principal and within TEN days after the awarding of the contract, enters into a proper contract in accordance with the bid, plans, details, specifications, and bills of material, which said contract is made a part of this bond the same as though set forth herein; and

IF THE SAID PRINCIPAL SHALL well and faithfully perform each and every condition of such contract; and indemnify the Obligee against all damage suffered by failure to perform such contract according to the provisions thereof and in accordance with the plans, details, specifications, and bills of material therefore; and shall pay all lawful claims of subcontractors, materialmen, and laborers, for labor performed and materials furnished in the carrying forward, performing, or completing of said contract: we agreeing and assenting that this undertaking shall be for benefit of any materialman or laborer having a just claim, as well as for the Obligee herein; **THEN THIS OBLIGATION SHALL** be void; otherwise the same shall remain in full force and effect; it being expressly understood and agreed that the liability of the Surety for any and all claims hereunder shall in no event exceed the penal amount of this obligation as herein stated.

THE SAID surety hereby stipulates and agrees that no modifications, omissions, or additions, in or to the terms of said contract or in or to the plans and specifications therefor shall in any wise affect the obligations of said surety on its bond, and it does hereby waive notice of any such modifications, omissions or additions to the terms of the contract or to the work or to the specifications.

SIGNED AND SEALED this ____ day of _____ 20_____.

PRINCIPAL

SURETY

By: _____

By: _____

Attorney-in-fact

Title: _____

Surety Agent's Name and Address:

PERFORMANCE BOND

KNOW ALL MEN BY THESE PRESENTS: that

(Name of Contractor)

(Address of Contractor)

a _____, hereinafter called
(Corporation, Partnership or Individual)

Principal, and _____
(Name of Surety)

(Address of Surety)

hereinafter called Surety, are held and firmly bound unto

WARREN COUNTY, OHIO BOARD OF COMMISSIONERS
406 Justice Drive
Lebanon, OH 45036

hereinafter called OWNER, in the penal sum of _____ Dollars, \$(_____) in
lawful money of the United States, for the payment of which sum well and truly to be made, we
bind ourselves, successors, and assigns, jointly and severally, firmly by these presents.

THE CONDITION OF THIS OBLIGATION is such that whereas, the Principal entered into a
certain contract with the OWNER, dated the _____ day of _____, 20_____,
a copy of which is hereto attached and made a part hereof for the construction of:

NOW THEREFORE, if the Principal shall well, truly and faithfully perform its duties, all the undertakings, covenants, terms, conditions, and agreements of said contract during the original term thereof, and any extensions thereof which may be granted by the OWNER, with or without notice to the Surety and during the guaranty period(s), and if he shall satisfy all claims and demands incurred under such contract, and shall fully indemnify and save harmless the OWNER from all costs and damages which it may suffer by reason of failure to do so, and shall reimburse and repay the OWNER all outlay and expense which the OWNER may incur in making good any default, then this obligation shall be void; otherwise to remain in full force and effect.

PROVIDED, FURTHER, that the said surety, for value received, hereby stipulates and agrees that no change, extension of time, alteration or addition of the terms of the contract or the WORK to be performed thereunder or the SPECIFICATIONS accompanying the same shall in any way affect its obligation on this BOND, and it does hereby waive notice of any such change, extension of time, alteration or addition to the terms of the contract or to the WORK or to the SPECIFICATIONS.

PROVIDED, FURTHER, that no final settlement between the OWNER and the CONTRACTOR shall abridge the right of any beneficiary hereunder, whose claim may be unsatisfied.

IN WITNESS WHEREOF, this instrument is executed in counterparts, each one of which shall be deemed an original, this the _____ day of _____ 20_____.

ATTEST:

(Principal)

By _____

(SEAL)

ATTEST:

(Surety)

(SEAL)

IMPORTANT: Surety companies executing BONDS must appear on the Treasury Department's most current list (Circular 570 as amended) and be authorized to transact business in the state where the PROJECT is located.

BONDING AND INSURANCE REQUIREMENTS

A state or local unit of government receiving a grant from the federal government which requires contracting for construction of facility improvement shall follow its own requirements relating to bid guarantees, performance bonds, and payment bonds, except for contracts or subcontracts exceeding \$100,000. For contracts or subcontracts exceeding \$100,000, the Federal agency may accept the bonding policy and requirements of the grantee provided the Federal agency has made a determination that the Government's interest is adequately protected. If such a determination has not been made, the minimum requirements shall be as follows:

- a. A bid guaranty from each bidder. The "bid guaranty" shall consist of a firm commitment such as a bid bond in the amount of one hundred (100) percent of the bid price, or ten (10) percent of the bid price if certified check or other negotiable instrument accompanying a bid, as assurance the bidder will, upon acceptance of his/her bid, execute such contractual documents as may be required within the time specified.

- b. A performance bond on the part of the Contractor for 100 percent of the contract price. A "performance bond" is one executed in connection with a contract to secure fulfillment of all the contractor's obligations under such contract.

AFFIDAVIT OF NON COLLUSION

STATE OF _____
COUNTY OF _____

I, _____, holding the title and position of _____ at the firm _____, affirm that I am authorized to speak on behalf of the company, board directors and owners in setting the price on the contract, bid or proposal. I understand that any misstatements in the following information will be treated as fraudulent concealment of true facts on the submission of the contract, bid or proposal.

I hereby swear and depose that the following statements are true and factual to the best of my knowledge:

The contract, bid or proposal is genuine and not made on the behalf of any other person, company or client, INCLUDING ANY MEMBER OF THE WARREN COUNTY BOARD OF COMMISSIONERS.

The price of the contract, bid or proposal was determined independent of outside consultation and was not influenced by other companies, clients or contractors, INCLUDING ANY MEMBER OF THE WARREN COUNTY BOARD OF COMMISSIONERS.

No companies, clients or contractors, INCLUDING ANY MEMBER OF THE WARREN COUNTY BOARD OF COMMISSIONERS have been solicited to propose a fake contract, bid or proposal for comparative purposes.

No companies, clients or contractors, INCLUDING ANY MEMBER OF THE WARREN COUNTY BOARD OF COMMISSIONERS have been solicited to refrain from bidding or to submit any form of noncompetitive bidding.

Relative to sealed bids, the price of the bid or proposal has not been disclosed to any client, company or contractor, INCLUDING ANY MEMBER OF THE WARREN COUNTY BOARD OF COMMISSIONERS, and will not be disclosed until the formal bid/proposal opening date.

AFFIANT

Subscribed and sworn to before me this _____ day of _____ 20 _____

(Notary Public),

_____ County.

My commission expires _____ 20 _____

SECTION VI

CONTRACT

CONTRACT

THIS AGREEMENT, made this ____ day of _____, 2021, by and between the Warren County Board of Commissioners, 406 Justice Drive, Lebanon, Ohio, hereinafter called "Owner" and _____, doing business as a corporation, hereinafter called "Contractor".

WITNESSETH: That for and in consideration of the payments and agreements hereinafter mentioned, to be made and performed by the Owner, the Contractor hereby agrees with the Owner to commence and complete the construction described as follows:

“FY2020 South Lebanon / Union Township – Lebanon Road Improvement CDBG Project”

hereinafter called the project, for the sum of _____ Dollars (\$_____) and all work in connection therewith, under the terms as stated in the Conditions of the Contract; and at his (its or their) own proper cost and expense furnish all the materials, supplies, machinery, equipment, tools, superintendence, labor, insurance and other accessories and services necessary to complete the said project in accordance with the conditions and prices stated in the Proposal, Conditions of the Contract, the specifications and Contract Documents. "Contract Documents" means and includes the following:

- A. Invitation to Bid
- B. Instructions to Bidders
- C. General Contract Conditions
- D. Technical Specifications
- E. Proposal Forms
 - Affidavit of Non-Delinquency of Personal Property Taxes
 - Bid Guarantee and Contract Bond
 - Non-collusion Affidavit
- F. Contract Forms
 - Notice of Award and Acceptance
 - Notice to Proceed and Acceptance
 - Change Order
- G. Conflict of Interest
 - Special Conditions Pertaining to Hazards Safety
 - Standards and Accident Prevention
 - Special Equal Opportunity Provisions (Section 3 Compliance)
 - Certifications of Compliance with Air and Water Acts
 - Architects Certification of Compliance with Minimum Standards for Accessibility by the Physically Handicapped
 - Designers Certification of Compliance with Minimum Standards or Accessibility by the Physically Handicapped
- H. Federal Labor Standards
 - Prevailing Wage Rates

The CONTRACTOR hereby agrees to commence work under this contract on or before a date to be specified in a Written "Notice to Proceed" of the OWNER and to fully complete the project by **November 18, 2021**. The Contractor further agrees to pay, as liquidated damages, the sum of \$100.00 for each consecutive calendar day thereafter until such time as work is completed.

Upon completion of said project, the CONTRACTOR shall submit an invoice to the OWNER. Upon approval by the Project Engineer, the submittal of a contractor's affidavit, and all prevailing wage reports, the OWNER shall make payment to the CONTRACTOR.

This Agreement may be terminated by either party upon written notice in the event of substantial failure by the other party to perform in accordance with the terms of this Agreement. The nonperforming party shall have fifteen (15) calendar days from the date of the termination notice to cure or to submit a plan for cure acceptable to the other party.

OWNER may terminate or suspend performance of this Agreement for OWNER'S convenience upon written notice to CONTRACTOR. CONTRACTOR shall terminate or suspend performance of the services/work on a schedule acceptable to the OWNER.

The CONTRACTOR will indemnify and save the OWNER, their officers and employees, harmless from loss, expenses, costs, reasonable attorney fees, litigation expenses, suits at law or in equity, causes of actions, actions, damages, and obligations arising from (a) negligent reckless or willful and wanton acts, errors, omissions by CONTRACTOR, its agents, employees, licensees, consultants or subconsultants; (b) the failure of the CONTRACTOR, its agents, employees, licensees, consultants or subconsultants to observe the applicable standard of care providing services pursuant to this agreement; (c) the intentional misconduct of the CONTRACTOR, its agents, employees, licensees, consultants or subconsultants that result in injury to persons or damage to property for which the OWNER may be held legally liable.

The CONTRACTOR does hereby agree to indemnify and hold the OWNER harmless for any and all sums for which the OWNER may be required to pay or for which the OWNER may be held responsible for failure of the CONTRACTOR or any subcontractor to pay the prevailing wage upon this project.

The OWNER agrees to pay the CONTRACTOR in the manner and at such times as set forth in the General Provisions such amounts as required by the Contract Documents.

This Agreement shall be binding upon all parties hereto and their respective heirs, executors, administrators, successors, and assigns.

CONTRACTOR shall bind every subcontractor to, and every subcontractor must agree to be bound by the terms of this Agreement, as far as applicable to the subcontractor's work particularly pertaining to Prevailing Wages and Equal Employment Opportunity (EEO) requirements. Nothing contained in this Agreement shall create any contractual relationship between any subcontractor and OWNER, nor create any obligations on the part of the OWNER to pay or see to the payment of any sums to any subcontractor.

IN WITNESS WHEREOF, the parties hereto have executed, or caused to be executed by their duly authorized officials, this Agreement in two counterparts, each of which shall be deemed an original on the date first above written.

(Seal)

WARREN COUNTY BOARD OF COMMISSIONERS

Tom Grossmann

ATTEST:

Shannon Jones

Name

David G. Young

(Seal)

CONTRACTOR

ATTEST:

Name

Name

Title

APPROVED AS TO FORM:

Keith Anderson
Assistant County Prosecutor

CERTIFICATIONS

I, _____, certify that I am the
(Name)

_____ of the corporation named as
(Position)

contractor herein; that _____ who signed
(Name)

this Agreement on behalf of the Contractor, was then

_____ of said corporation; that said Agreement
(Position)

was duly signed for and in behalf of said corporation by authority of its governing body, and is within the scope of its corporate powers.

_____ Corporate

_____ Seal

PERFORMANCE AND PAYMENT BOND (OR BONDS)

Following the Form of Agreement, attach the approved form of the statutory surety bond or bonds to insure the performance of the Contract and payment of labor and materials. In addition to the corporation signatures of the surety company(ies) on the bond(s), each bond should be countersigned by the surety company's attorney-in-fact, authorized to act within the state in which the Project is situated.

SECTION VII

FEDERAL AND STATE REQUIREMENTS

CONFLICT OF INTEREST

Interest of Local Public Officials

No member of the governing body of the locality and no other officer, employee, agent or public official of such locality, who exercises any functions or responsibilities in connection with the planning and carrying out of the program, shall have any personal financial interest, direct or indirect, in this contract; and the Contractor shall take appropriate steps to assure compliance.

Interest of Contractor and Employees

The Contractor covenants that he presently has no interest and shall not acquire interest, direct or indirect, in the study area or any parcels therein or any other interest which would conflict in any manner or degree with the performance of his services hereunder. The Contractor further covenants that in the performance of this Contract, no person having any such interest shall be employed.

Records and Audits

The Contractor shall maintain accounts and records, including personnel, property and financial records, adequate to identify and account for all costs pertaining to the Contract and such other records as may be deemed necessary by the City/County to assure proper accounting for all project funds. These records will be made available for audit purposes to the City/County to assure proper accounting for all project funds. These records will be made available for audit purposes to the City/County or any authorized representative and will be retained for three years after the expiration of his Contract unless permission to destroy them is granted by the City/County.

Federal or State Officials Not to Benefit

No members of or delegate to the Congress of the United States of America and no resident U.S. Commissioner. Nor any officer or employee of the State of Ohio subject to Ohio Ethics Law (ORC. Sec102.03(A)) will be admitted to any share or part hereof or to any benefit to arise here from.

SPECIAL CONDITIONS PERTAINING TO HAZARDS, SAFETY STANDARDS AND ACCIDENT PREVENTION

A. Lead-Based Paint Hazards

(Applicable to contracts for construction or rehabilitation of residential structures)

The construction or rehabilitation of residential structures is subject to the HUD Lead-Based Paint regulations, 24 CFR Part 35. The Contractor and Subcontractors shall comply with the provisions for the elimination of lead base paint hazards under sub-part B of said regulations. The Owner will be responsible for the inspections and certifications required under Section 35.14(1) thereof.

B. Use of Explosives

When the use of explosives is necessary for the prosecution of the work, the Contractor shall observe all local, state and Federal Laws in purchasing and handling explosives. The Contractor shall take all necessary precaution to protect completed work, neighboring property, water lines, or other underground structures, Where there is danger to structures or property from blasting, the charges shall be reduced and the material shall be covered with suitable timber, steel or rope mats.

The Contractor shall notify all owners of public utility property of intention to use explosives at least eight hours before blasting is done, close to such property. Any supervision or direction of use of explosives by the Engineer does not in any way reduce the responsibility of the Contractor or his Surety for damages that may be caused by such use.

C. Danger Signals And Safety Devices

The Contractor shall make all necessary precautions to guard against damages to property and injury to persons. He shall put up and maintain in good condition, sufficient red or warning lights at night, suitable barricades and other devices necessary to protect the public. In case the Contractor fails or neglects to take such precautions, the Owner may have such lights and barricades installed and charge the cost of this work to the contractor. Such action by the Owner does not relieve the Contractor of any liability incurred under these specifications or contract.

SPECIAL EQUAL OPPORTUNITY PROVISIONS

A. Activities and Contracts Not Subject to Executive Order 11246, as Amended

(Applicable to Federally assisted construction contracts and related subcontracts \$10,000 and under)

During the performance of this contract the contractor agrees as follows:

1. The Contractor shall not discriminate against any employee or applicant for employment because of race, color, religion, sex, or national origin. The Contractor shall take affirmative action to ensure that applicants for employment are employed and that employees are treated during employment, without regard to their race, color, religion, sex, or national origin. Such action shall include, but not be limited to, the following: employment, upgrading, demotion, or transfer; recruitment or recruitment advertising; layoff or termination; rates of pay or other forms of compensation; and selection for training, including apprenticeship.
2. The Contractor shall post in conspicuous places available to employees and applicants for employment notices to be provided by the Owner setting forth the provisions of this non-discrimination clause. The Contractor shall state that all qualified applicants will receive consideration for employment without regard to race, color, religion, sex, or national origin.
3. Contractors shall incorporate foregoing requirements in all subcontracts.

B. Executive Order 11246 (Contracts/subcontracts above \$10,000)

1. Section 202 Equal Opportunity Clause

During the performance of this contract, the contractor agrees as follows:

- (1) The contractor will not discriminate against any employee or applicant for employment because of, race, color, religion, sex, or national origin. The contractor will take affirmative action to ensure that applicants are employed, and that employees are treated during employment, without regard to their race, color, religion, sex, or national origin. Such action shall include, but not be limited to the following: Employment, upgrading, demotion, or transfer; recruitment, or recruitment advertising; layoff or termination, rates of pay or other forms of compensation; and selection for training, including apprenticeship. The contractor agrees to post in conspicuous places, available to employees and applicants for employment notices to be provided by the Owner setting forth the provisions of this non-discrimination clause
- (2) The contractor will, in all solicitations or advertisements for employees placed by or on behalf of the contractor, state that all qualified applicants will receive consideration without regard to race, color, religion, sex, or national origin
- (3) The contractor will send to each Labor union or representative of workers with which he has a collective bargaining agreement or other contractor or understanding, a notice to be provided by the Owner advising the said labor union or workers representatives of the contractor's commitment under this section, and shall post copies of the notice in conspicuous places available to employees and applicants for employment
- (4) The contractor will comply with all provisions of Executive Order 11246 of September 24, 1965, and of the rules, regulations, and relevant orders of the Secretary of Labor
- (5) The Contractor will furnish all information and reports required by Executive Order 11246 of September 24, 1965, and by rules, regulations and orders of the Secretary of Labor, or pursuant thereto, and will permit access to his/her books, records, and accounts by the Ohio Department of Development's Office of Local Government Services (OLGS), the U.S. Department of Housing and Urban Development and/or the U.S Department of Labor and the Secretary of Labor for purposes of investigation to ascertain compliance with such rules, regulations, and others.
- (6) In the event of the contractor's non-compliance with the non-discrimination clauses of this contract or with any of the said rules, regulations, or orders, this contract may be canceled, terminated, or suspended in whole or in part and the contractor may be declared ineligible for further Government contracts in accordance with procedures authorized in Executive Order 11246 of September 24, 1965, or by rules, regulations or orders of the Secretary of Labor, or as otherwise provided by law.
- (7) The contractor will include the provisions of the sentence immediately preceding paragraph (1) and the provisions of paragraphs (1) through (7) in every subcontract or purchase order unless exempted by rules, regulations, or orders of the Secretary of Labor issued pursuant to Section 204 of Executive Order 11246 of September 24, 1965, so that such provisions will be binding upon each subcontractor or vendor. The contractor will take such action with respect to any subcontract or purchase order as the Department may direct as a means of enforcing such provisions, including sanctions for non-compliance. Provided, however, that in the event a contractor becomes involved in, or is threatened with, litigation with a subcontractor or vendor as a result of such direction by the Department, the contractor may request the United States to enter into such litigation to protect the interest of the United States.

2. Notice of Requirement for Affirmative Action To Ensure Equal Employment Opportunity (Executive Order 11246).
(Applicable to contracts/subcontracts exceeding \$10,000)

- (1) The Offerer's Of Bidder's attention is called to the "Equal Opportunity CJauso" and the "Standard Federal Equal Employment Opportunity Construction Contract Specifications" set forth herein.
- (2) The goals and timetables for minority and female participation, expressed in percentage terms for the Contractor's aggregate work force in each trace on all construction work in the covered area, are as follows:

Goals for Minority Participation 11.0%

Goals for Female Participation 6.9%

These goals are applicable to all the Contactors construction work (whether or not it is Federal or Federally assisted) performed. in the covered areas. The Contractor's compliance with the Executive Order and the regulations in 41 CFR. Part 60-4 shall be based on its implementation of the Equal Opportunity Clause, specific affirmative action obligations required by the specifications set forth in 41 CFR 60-4.3(a), and its efforts to meet the goats established for the geographical area where the contract resulting from this solicitation is to be performed. The hours of minority and female employment and training must be substantially uniform throughout the length of the contract, and in each trade, and the contractor shall make n good faith effort to employ minorities and women evenly on each of its projects. The transfer of minority or female employees or trainees from Contractor to Contractor or from project to project for the sole purpose of meeting the Contractor's goals shall be a violation of the contract. the Executive Order and the regulations in 41 CFR Part 60-4. Compliance with the goals will be measured against the total work hours performed

- (3) The contractor shall provide written notification to the Manager of the Office of Local Government Services, Ohio Department of Development, P.O. Box 1001, Columbus, Ohio 43266-0101 within 10 working days of award of any construction subcontract in excess of \$10,000 at any tier for construction work under the contract resulting from this solicitation. The notification shall list the name, address and telephone number of the subcontractor; employer identification number; estimated dollar amount of the subcontract; estimated statlillg and completion dates of the subcontract; and the geographical area in which the contract is to be performed.
- (4) As used Notice, and in the contract resulting from this solicitation, the "covered area" is in the State of Ohio. And County of Warren.

STANDARD FEDERAL EQUAL EMPLOYMENT OPPORTUNITY CONSTRUCTION CONTRACT SPECIFICATIONS (EXECUTIVE ORDER 11246)

1. As used in these specifications:

- a. ``Covered area" means the geographical area described in the solicitation from which this contract resulted;
- b. ``Director" means Director, Office of Federal Contract Compliance Programs, United States Department of Labor, or any person to whom the Director delegates authority;
- c. ``Employer identification number" means the Federal Social Security number used on the Employer's Quarterly Federal Tax Return, U.S. Treasury Department Form 941.
- d. ``Minority" includes:

- (i) Black (all persons having origins in any of the Black African racial groups not of Hispanic origin);
- (ii) Hispanic (all persons of Mexican, Puerto Rican, Cuban, Central or South American or other Spanish Culture or origin, regardless of race);
- (iii) Asian and Pacific Islander (all persons having origins in any of the original peoples of the Far East, Southeast Asia, the Indian Subcontinent, or the Pacific Islands); and
- (iv) American Indian or Alaskan Native (all persons having origins in any of the original peoples of North America and maintaining identifiable tribal affiliations through membership and participation or community identification).

2. Whenever the Contractor, or any Subcontractor at any tier, subcontracts a portion of the work involving any construction trade, it shall physically include in each subcontract in excess of \$10,000 the provisions of these specifications and the Notice which contains the applicable goals for minority and female participation and which is set forth in the solicitations from which this contract resulted.

3. If the Contractor is participating (pursuant to 41 CFR 60-4.5) in a Hometown Plan approved by the U.S. Department of Labor in the covered area either individually or through an association, its affirmative action obligations on all work in the Plan area (including goals and timetables) shall be in accordance with that Plan for those trades which have unions participating in the Plan. Contractors must be able to demonstrate their participation in and compliance with the provisions of any such Hometown Plan. Each Contractor or Subcontractor participating in an approved Plan is individually required to comply with its obligations under the EEO clause, and to make a good faith effort to achieve each goal under the Plan in each trade in which it has employees. The overall good faith performance by other Contractors or Subcontractors toward a goal in an approved Plan does not excuse any covered Contractor's or Subcontractor's failure to take good faith efforts to achieve the Plan goals and timetables.

4. The Contractor shall implement the specific affirmative action standards provided in paragraphs 7 a through p of these specifications. The goals set forth in the solicitation from which this contract resulted are expressed as percentages of the total hours of employment and training of minority and female utilization the Contractor should reasonably be able to achieve in each construction

trade in which it has employees in the covered area. Covered Construction contractors performing construction work in geographical areas where they do not have a Federal or federally assisted construction contract shall apply the minority and female goals established for the geographical area where the work is being performed. Goals are published periodically in the Federal Register in notice form, and such notices may be obtained from any Office of Federal Contract Compliance Programs office or from Federal procurement contracting officers. The Contractor is expected to make substantially uniform progress in meeting its goals in each craft during the period specified.

5. Neither the provisions of any collective bargaining agreement, nor the failure by a union with whom the Contractor has a collective bargaining agreement, to refer either minorities or women shall excuse the Contractor's obligations under these specifications, Executive Order 11246, or the regulations promulgated pursuant thereto.

6. In order for the nonworking training hours of apprentices and trainees to be counted in meeting the goals, such apprentices and trainees must be employed by the Contractor during the training period, and the Contractor must have made a commitment to employ the apprentices and trainees at the completion of their training, subject to the availability of employment opportunities. Trainees must be trained pursuant to training programs approved by the U.S. Department of Labor.

7. The Contractor shall take specific affirmative actions to ensure equal employment opportunity. The evaluation of the Contractor's compliance with these specifications shall be based upon its effort to achieve maximum results from its actions. The Contractor shall document these efforts fully, and shall implement affirmative action steps at least as extensive as the following:

- a. Ensure and maintain a working environment free of harassment, intimidation, and coercion at all sites, and in all facilities at which the Contractor's employees are assigned to work. The Contractor, where possible, will assign two or more women to each construction project. The Contractor shall specifically ensure that all foremen, superintendents, and other on-site supervisory personnel are aware of and carry out the Contractor's obligation to maintain such a working environment, with specific attention to minority or female individuals working at such sites or in such facilities.
- b. Establish and maintain a current list of minority and female recruitment sources, provide written notification to minority and female recruitment sources and to community organizations when the Contractor or its unions have employment opportunities available, and maintain a record of the organizations' responses.
- c. Maintain a current file of the names, addresses and telephone numbers of each minority and female off-the-street applicant and minority or female referral from a union, a recruitment source or community organization and of what action was taken with respect to each such individual. If such individual was sent to the union hiring hall for referral and was not referred back to the Contractor by the union or, if referred, not employed by the Contractor, this shall be documented in the file with the reason therefore, along with whatever additional actions the Contractor may have taken.
- d. Provide immediate written notification to the Director when the union or unions with which the Contractor has a collective bargaining agreement has not referred to the Contractor a minority person or woman sent by the Contractor, or when the Contractor has other information that the union referral process has impeded the Contractor's efforts to meet its obligations.
- e. Develop on-the-job training opportunities and/or participate in training programs for the area which expressly include minorities and women, including upgrading programs and apprenticeship and trainee programs relevant to the Contractor's employment needs, especially those programs funded or approved by the Department of Labor. The Contractor shall provide notice of these programs to the sources compiled under 7b above.
- f. Disseminate the Contractor's EEO policy by providing notice of the policy to unions and training programs and requesting their cooperation in assisting the Contractor in meeting its EEO obligations; by including it in any policy manual and collective bargaining agreement; by publicizing it in the company newspaper, annual report, etc.; by specific review of the policy with all management personnel and with all minority and female employees at least once a year; and by posting the company EEO policy on bulletin boards accessible to all employees at each location where construction work is performed.
- g. Review, at least annually, the company's EEO policy and affirmative action obligations under these specifications with all employees having any responsibility for hiring, assignment, layoff, termination or other employment decisions including specific review of these items with onsite supervisory personnel such as Superintendents, General Foremen, etc., prior to the initiation of construction work at any job site. A written record shall be made and maintained identifying the time and place of these meetings, persons attending, subject matter discussed, and disposition of the subject matter.
- h. Disseminate the Contractor's EEO policy externally by including it in any advertising in the news media, specifically including minority and female news media, and providing written notification to and discussing the Contractor's EEO policy with other Contractors and Subcontractors with whom the Contractor does or anticipates doing business.
- i. Direct its recruitment efforts, both oral and written, to minority, female and community organizations, to schools with minority and female students and to minority and female recruitment and training organizations serving the Contractor's recruitment area and employment needs. Not later than one month prior to the date for the acceptance of applications for apprenticeship or other training by any recruitment source, the Contractor shall send written notification to organizations such as the above, describing the openings, screening procedures, and tests to be used in the selection process.
- j. Encourage present minority and female employees to recruit other minority persons and women and, where reasonable, provide after school, summer and vacation employment to minority and female youth both on the site and in other areas of a Contractor's work force.
- k. Validate all tests and other selection requirements where there is an obligation to do so under 41 CFR Part 60-3.
- l. Conduct, at least annually, an inventory and evaluation at least of all minority and female personnel for promotional opportunities and encourage these employees to seek or to prepare for, through appropriate training, etc., such opportunities.

- m. Ensure that seniority practices, job classifications, work assignments and other personnel practices, do not have a discriminatory effect by continually monitoring all personnel and employment related activities to ensure that the EEO policy and the Contractor's obligations under these specifications are being carried out.
 - n. Ensure that all facilities and company activities are nonsegregated except that separate or single-user toilet and necessary changing facilities shall be provided to assure privacy between the sexes.
 - o. Document and maintain a record of all solicitations of offers for subcontracts from minority and female construction contractors and suppliers, including circulation of solicitations to minority and female contractor associations and other business associations.
 - p. Conduct a review, at least annually, of all supervisors' adherence to and performance under the Contractor's EEO policies and affirmative action obligations.
 - q. Covered construction contractors performing contracts in geographical areas where they do not have a federal or federally assisted construction contract shall apply to the minority and female goals established for the geographical area where the contract is being performed, Goals are published periodically in the Federal Register in notice form and such notices may be obtained from any Office of Federal Contract Compliance Programs office or from Federal procurement contracting offices.
8. Contractors are encouraged to participate in voluntary associations which assist in fulfilling one or more of their affirmative action obligations (7a through q). The efforts of a contractor association, joint contractor-union, contractor-community, or other similar group of which the contractor is a member and participant, may be asserted as fulfilling any one or more of its obligations under 7a through q of these Specifications provided that the contractor actively participates in the group, makes every effort to assure that the group has a positive impact on the employment of minorities and women in the industry, ensures that the concrete benefits of the program are reflected in the Contractor's minority and female workforce participation, makes a good faith effort to meet its individual goals and timetables, and can provide access to documentation which demonstrates the effectiveness of actions taken on behalf of the Contractor. The obligation to comply, however, is the Contractor's and failure of such a group to fulfill an obligation shall not be a defense for the Contractor's noncompliance.
9. A single goal for minorities and a separate single goal for women have been established. The Contractor, however, is required to provide equal employment opportunity and to take affirmative action for all minority groups, both male and female, and all women, both minority and non-minority. Consequently, the Contractor may be in violation of the Executive Order if a particular group is employed in a substantially disparate manner (for example, even though the Contractor has achieved its goals for women generally, the Contractor may be in violation of the Executive Order if a specific minority group of women is underutilized).
10. The Contractor shall not use the goals and timetables or affirmative action standards to discriminate against any person because of race, color, religion, sex, or national origin.
11. The Contractor shall not enter into any Subcontract with any person or firm debarred from Government contracts pursuant to Executive Order 11246.
12. The Contractor shall carry out such sanctions and penalties for violation of these specifications and of the Equal Opportunity Clause, including suspension, termination and cancellation of existing subcontracts as may be imposed or ordered pursuant to Executive Order 11246, as amended, and its implementing regulations, by the Office of Federal Contract Compliance Programs. Any Contractor who fails to carry out such sanctions and penalties shall be in violation of these specifications and Executive Order 11246, as amended.
13. The Contractor, in fulfilling its obligations under these specifications, shall implement specific affirmative action steps, at least as extensive as those standards prescribed in paragraph 7 of these specifications, so as to achieve maximum results from its efforts to ensure equal employment opportunity. If the Contractor fails to comply with the requirements of the Executive Order, the implementing regulations, or these specifications, the Director shall proceed in accordance with 41 CFR 60-4.8.
14. The Contractor shall designate a responsible official to monitor all employment related activity to ensure that the company EEO policy is being carried out, to submit reports relating to the provisions hereof as may be required by the Government and to keep records. Records shall at least include for each employee the name, address, telephone numbers, construction trade, union affiliation if any, employee identification number when assigned, social security number, race, sex, status (e.g., mechanic, apprentice trainee, helper, or laborer), dates of changes in status, hours worked per week in the indicated trade, rate of pay, and locations at which the work was performed. Records shall be maintained in an easily understandable and retrievable form; however, to the degree that existing records satisfy this requirement, contractors shall not be required to maintain separate records.
15. Nothing herein provided shall be construed as a limitation upon the application of other laws which establish different standards of compliance or upon the application of requirements for the hiring of local or other area residents (e.g., those under the Public Works Employment Act of 1977 and the Community Development Block Grant Program).

C. CERTIFICATION OF NONSEGREGATED FACILITIES (Over \$10,000)

By the submission of this bid, the bidder, offerer, applicant, or subcontractor certifies that he does not maintain or provide for his employees any segregated facilities at any of his establishments, and that he does not permit his employees to perform their services at any location under his control where segregated facilities are maintained. He certifies further that he will not maintain or provide for his employees any segregated facilities at any of his establishments, and that he will not permit his employees to perform their services at any location under his control where segregated facilities are maintained. The bidder, offerer, applicant, or subcontractor agrees that a breach of this certification is a violation of the Equal Opportunity clause in this proposed contract. As used in this certification, the term "segregated facilities" means any waiting rooms, work areas, rest rooms and wash rooms, restaurants, and other eating areas, time clocks, locker rooms and other storage or dressing areas, parking lots, drinking fountains,

recreation or entertainment areas, transportation, and housing facilities provided for employees which are segregated by explicit directive, or are in fact segregated on the basis of race, creed, color, or national origin because of habit, local custom, or otherwise. He further agrees that (except where he has obtained identical certifications from proposed subcontractors for specific time periods) he will obtain identical certifications from proposed contractors for prior to the award of subcontracts exceeding \$10,000 which are not exempt from his provisions of the Equal Opportunity clause; that he will retain such certifications in files; and that he will forward the following notice to such proposed subcontractors (except where the proposed subcontractors have submitted identical certifications for specific time periods).

D. Civil Rights Act of 1964

Under Title VI of the Civil Rights Act of 1964, no shall, on the grounds of race, color or national origin, be excluded from participation in, be denied the benefits of, or be subjected to discrimination under any program or activity receiving Federal financial assistance.

E. Section 109 of the Housing and Community Development act of 1974

No person in the United States shall on the ground of race, color, national origin, religion, or sex be excluded from participation in, be denied the benefits of, or be subjected to discrimination under any program or activity funded in whole or in part with funds made available under this title.

F. "Section 3" Compliance in the Provision of Training Employment and Business Opportunities

- a. The work to be performed under this contract is on a project assisted under a program providing direct federal financial assistance from the Department of Housing and Urban Development through the Indiana Office of Community and Rural Affairs and is subject to the requirements of Section 3 of the Housing and Urban Development Act of 1968, as amended, 12 USC, 1701u. Section 3 requires that to the greatest extent feasible, opportunities for training and employment be given to lower income residents of the project area and contracts for work in connection with the project be awarded to business concerns which are located in, or owned in substantial part by persons residing in the area of the project.
- b. The parties to this contract will comply with the provisions of said Section 3 and the regulations issued pursuant thereto by the Secretary of Housing and Urban Development set forth in 24 CFR 135, and all applicable rules and orders of the Department issued thereunder prior to the execution of this contract. The parties to this contract certify and agree that they are under no contractual or other disability which would prevent them from complying with these requirements.
- c. The contractor will send to each labor organization or representative of workers with which he has a collective bargaining agreement or other contract or understanding, if any, a notice advising the said labor organization or workers representative of his commitments under this Section 3 clause and shall post copies of the notice in conspicuous places available to employees and applicants for employment or training.
- d. The contractor will include this Section 3 clause in every subcontract for work in connection with the project and will, at the discretion of the applicant for recipient of Federal financial assistance, take appropriate action pursuant to the subcontract upon a finding that the subcontractor is in violation of regulations issued by the . Secretary of Housing and Urban Development, 24 CFR Part 135, The contractor will not subcontract with any subcontractor where it has notice or knowledge that the latter has been found in violation of regulations under 24 CFR. Part 135 and will not let any subcontract unless the subcontractor has first provided it with a preliminary statement of ability to comply with the requirements of these regulations.
- e. Compliance with the provisions of Section 3, the regulations set forth in 24 CFR Part 135, and all applicable rules and orders of the Department issued hereunder prior to the execution of the contract, shall be a condition of the federal financial assistance provided to the project, binding upon the applicant or recipient for such assistance, its successors and assigns. Failure to fulfill these requirements shall subject the applicant or recipient, its contractors and subcontractors, its successors and assigns to those sanctions specified by the grant or loan agreement or contract through which federal assistance is provided, and to such sanctions as are specified by 24 CFR Part 135.

CONTRACTOR
Section 3 Plan Format

_____ agrees to implement the following specific affirmative action steps directed at increasing the utilization of lower income residents and businesses within the County of Warren.

- A. To ascertain from the locality's CDBG program official the exact boundaries of the Section 3 covered project area and where advantageous, seek the assistance of local officials in preparing and implementing the affirmative action plan.
- B. To attempt to recruit from within the COUNTY the necessary number of lower income residents through: local advertising media, signs placed at the proposed site for the project, and community organizations and public or private institutions operating within or serving the project area such as Service Employment and Redevelopment (SER), Opportunities Industrialization Center (OIC), Urban League, Concentrated Employment Program, Hometown Plan, or the U. S .Employment Service.
- C. To maintain a list of all lower income residents who have applied either on their own or on referral from any source, and to employ such persons, if otherwise eligible and if a vacancy exists.
- D. *To insert this Section 3 Plan in all bid documents, and to require all bidders on subcontracts to submit a Section 3 Plan including utilization goals and the specific steps planned to accomplish these goals.
- E. *To ensure that subcontracts, which are typically let on a negotiated rather than a bid basis, in areas other than Section 3 covered project areas, are also let on a negotiated basis whenever feasible, if let in a Section 3 covered project area.
- F. *To formally contact unions, subcontractors, and trade associations to secure their cooperation for this program.
- G. To ensure that all appropriate project area business concerns are notified of pending subcontractual opportunities.
- H. To maintain records, including copies of correspondence, memoranda, etc. which document that all of the above affirmative action steps have been taken.
- I. To appoint or recruit an executive official of the company or agency as Equal Opportunity Officer to coordinate the implementation of this Section 3 Plan.
- J. To list on Table A information related to subcontracts to be awarded.
- K. To list on Table B all projected workforce needs for all phases of this project by occupation, trade, skill level, and number of positions.

As officers and representatives of _____, we the undersigned have read and fully agree to this Section 3 Plan, and become a party to the full implementation of this program.

Signature

Title

Date

Signature

Title

Date

*Loans, grants, contracts and subsidies for less than \$10,000 will be exempt.

TABLE B
BIDDER'S SECTION 3 ESTIMATED NEW HIRES

Job Category	Total Estimated Positions Needed for Project	No. Positions Occupied By Permanent Employees	No. Positions Not Occupied	No. Positions To Be Filled w/ Section 3 Residents
Officers/Supervisors				
Professionals				
Technical				
Housing Sales/Rental/Mgmt.				
Office Clerical				
Service Workers				
Others				

TRADE:

Journeyman				
Apprentices				
Maximum No. Trainees				
Others				

TRADE:

Journeyman				
Helpers				
Apprentices				
Maximum No. Trainees				
Others				

Section 3 Resident Individual residing within the non-metropolitan county in which the Section 3 covered project is located and whose income does not exceed 80% of the higher or the median income, adjusted by family size, for the county of residence of the 000-metropolitan area of the state.

 Company

 Project Name

 Project Number

 Person Completing Form

 Date

CERTIFICATION OF BIDDER REGARDING EQUAL EMPLOYMENT OPPORTUNITY INSTRUCTIONS

This certification is required pursuant to Executive Order 11246 (30 F.R. 12319-25). The implementing rules and regulations provide that any bidder or prospective contractor, or any of their proposed subcontractors, shall state as an initial part of the bid or negotiations of the contract, whether it has participated in any previous contract or subcontract subject to the equal opportunity clause; and, if so, whether it has files all compliance reports due under applicable instructions. Where the certification indicates that the bidder has not filed a compliance report due under applicable instructions, such bidders shall be required to submit a compliance report within seven (7) calendar days after bid opening. No contract shall be awarded unless such report is submitted.

CERTIFICATION BY BIDDER

Bidder's Name: _____

Address and Zip Code: _____

1. Bidder has participated in previous contract or subcontract subject to the Equal Employment Opportunity Clause.
 Yes No

2. Compliance reports were required to be filed in connection with such contract or subcontract.
 Yes No

3. Bidder has filed all compliance reports due under applicable instructions, including SF- 100.
 Yes No

4. Have you ever been or are you being considered for sanction due to violation of Executive Order 11246, as amended?

Name and Title of Signer (Please type): _____

Signature

Date

**CERTIFICATION OF PROPOSED SUBCONTRACTOR
REGARDING EQUAL EMPLOYMENT OPPORTUNITY**

Name of Prime Contractor

Project Number

INSTRUCTIONS

This certification is required pursuant to Executive Order 11246 (30 F.R. 12319-25). The implementing rules and regulations provide that any bidder or prospective contractor, or any of their proposed subcontractors, shall state as in initial part of the bid or negotiations of the contract whether it has participated in any previous contract or subcontract subject to the equal opportunity clause; and, if so, whether it has filed all compliance reports due under applicable instructions.

Where the certification indicates that the bidder has not filed a compliance report due under applicable instructions, such subcontractor shall be required to submit a compliance report before the owner approves the subcontract or permits work to begin under the subcontract.

SUBCONTRACTOR'S CERTIFICATION

Name and Address of Subcontractor (include zip code):

1. Bidder has participated in a previous contract or subcontract subject to the Equal Opportunity Clause

YES NO

2. Compliance Reports were required to be filed in connection with such contract or subcontract.

YES NO

3. Bidder has filed all compliance reports due under applicable instructions, including SF-100.

YES NO NOT REQUIRED

4. Have you ever been or are you being considered for sanction due to violation of Executive Order 11246, as amended?

YES NO

Name and Title of Signer (please type)

Signature

Date

CERTIFICATION OF PROPOSED CONTRACTOR REGARDING SECTION 3 AND SEGREGATED FACILITIES

Name of Contractor

Project Name and Number

The undersigned hereby certifies that:

- a) Section 3 provisions are included in the contract:
- b) A written Section 3 Clause was prepared and submitted as part of the bid proceedings (If the bid equals or exceeds \$100,000);
- c) No segregated facilities will be maintained.

Print or type Name & Title of Person Signing

Signature

Date

CERTIFICATION OF PROPOSED SUBCONTRACTOR REGARDING SECTION 3 AND SEGREGATED FACILITIES

Name of Subcontractor

Project Name and Number

The undersigned hereby certifies that:

- (a) Section 3 provisions are included in the Contract,
- (b) A written Section 3 plan was prepared and submitted as part of the bid proceedings (if bid equals or exceeds \$100,000), and
- (c) Tables A and B were prepared and submitted as part of the bid proceedings (if bid equals or exceeds \$100,000).
- (d) No segregated facilities will be maintained as required by Title VI of the Civil Rights Act of 1964.

Name & Title of Signer (Print or Type)

Signature

Date

CERTIFICATION OF COMPLIANCE WITH AIR AND WATER ACTS

(applicable to contracts and subcontracts exceeding \$100,000)

The Contractor and all subcontractors shall comply with the requirements of the Clean Air Act, as amended, 42 USC 1857 et seq., the Federal Water Pollution Control Act, as amended, 33 USC 1251 et seq., and the regulations of the Environmental Protection Agency with respect thereto, at 40 CFR Part 15, as amended.

In addition to the foregoing requirements, all nonexempt contractors and subcontractors shall furnish to the owner, the following:

1. A stipulation by the Contractor or subcontractors, that any facility to be utilized in the performance of any nonexempt contract or subcontract, is not listed on the List of Violating Facilities issued by the Environmental Protection Agency (EPA) pursuant to 40 CFR Part 15, as amended.
2. Agreement by the Contractor to comply with all the requirements of Section 114 of the Clean Air Act, as amended, (42 USC 1857 c-8) and Section 308 of the Federal Water Pollution Control Act, as amended, (33 USC 1318) relating to inspection, monitoring, entry, reports and information, as well as all other requirements specified in said Section 114 and Section 308, and all regulations and guidelines issued thereunder.
3. A stipulation that as a condition for the award of the contract, prompt notice will be given of any notification received from the Director, Office of Federal Activities, EPA, indicating that a facility utilized, or to be utilized for the contract, is under consideration to be listed on the EPA List of Violating Facilities.
4. Agreement by the Contractor that he will include, or cause to be included, the criteria and requirements in paragraph (1) through (4) of this section in every nonexempt subcontract and requiring that the Contractor will take such action as the government may direct as a means of enforcing such provisions.

ARCHITECT'S CERTIFICATION COMPLIANCE
WITH MINIMUM STANDARDS FOR ACCESSIBILITY BY THE PHYSICALLY HANDICAPPED

Grantee No.: _____

Project Name: _____

Pursuant to the requirements of the Architectural Barriers Act of 1968, 42 U.S.C. 4151, and the regulations issued subsequent thereto, the undersigned certifies that the design of the above-mentioned project is in conformance with the minimum standards contained in the American Standard Specifications for Making Buildings and Facilities Accessible To and Usable By the Physically Handicapped, Number A-117.IR-1971 (as modified by 41 CFR 101-19.603).

Architect, Engineer or Contractor for the Project: (Legal Name and Address):

Signature: _____

Date: _____

Name of Chief Local Executive Official: _____

Signature: _____

Date: _____

DESIGNER CERTIFICATION COMPLIANCE
WITH MINIMUM STANDARDS FOR ACCESSIBILITY BY THE PHYSICALLY HANDICAPPED

Grantee No.: _____

Project Name: _____

Pursuant to the requirements of the Architectural Barriers Act of 1968, 42 U.S.C. 4151, and the regulations issued subsequent thereto, the undersigned certifies that the design of the above-mentioned project is in conformance with the minimum standards contained in the American Standard Specifications for Making Buildings and Facilities Accessible To and Usable By the Physically Handicapped, Number A-117.IR-1971 (as modified by 41 CFR 101-19.603).

Architect, Engineer or Contractor for the Project: (Legal Name and Address):

Signature: _____

Date: _____

Name of Chief Local Executive Official: _____

Signature: _____

Date: _____

SECTION VIII

FEDERAL LABOR STANDARDS PROVISIONS

Federal Labor Standards Provisions

U.S. Department of Housing and Urban Development Office of Labor Relations

Applicability

The Project or Program to which the construction work covered by this contract pertains is being assisted by the United States of America and the following Federal Labor Standards Provisions are included in this Contract pursuant to the provisions applicable to such Federal assistance.

A. 1. (I) **Minimum Wages.** All laborers and mechanics employed or working upon the site of the work, will be paid unconditionally and not less often than once a week, and without subsequent deduction or rebate on any account (except such payroll deductions as are permitted by regulations issued by the Secretary of Labor under the Copeland Act (29 CFR Part 3), the full amount of wages and bona fide fringe benefits (or cash equivalents thereof) due at time of payment computed at rates not less than those contained in the wage determination of the Secretary of Labor which is attached hereto and made a part hereof, regardless of any contractual relationship which may be alleged to exist between the contractor and such laborers and mechanics. Contributions made or costs reasonably anticipated for bona fide fringe benefits under Section 1(b)(2) of the Davis-Bacon Act on behalf of laborers or mechanics are considered wages paid to such laborers or mechanics, subject to the provisions of 29 CFR 5.5(a)(1)(iv); also, regular contributions made or costs incurred for more than a weekly period (but not less often than quarterly) under plans, funds, or programs, which cover the particular weekly period, are deemed to be constructively made or incurred during such weekly period.

Such laborers and mechanics shall be paid the appropriate wage rate and fringe benefits on the wage determination for the classification of work actually performed, without regard to skill, except as provided in 29 CFR 5.5(a)(4). Laborers or mechanics performing work in more than one classification may be compensated at the rate specified for each classification for the time actually worked therein; Provided, That the employer's payroll records accurately set forth the time spent in each classification in which work is performed. The wage determination (including any additional classification and wage rates conformed under 29 CFR 5.5(a)(1)(ii) and the Davis-Bacon poster (WH-1321) shall be posted at all times by the contractor and its subcontractors at the site of the work in a prominent and accessible, place where it can be easily seen by the workers.

(II) (a) Any class of laborers or mechanics which is not listed in the wage determination and which is to be employed under the contract shall be classified in conformance with the wage determination. HUD shall approve an additional classification and wage rate and fringe benefits herefor only when the following criteria have been met:

(1) The work to be performed by the classification requested is not performed by a classification in the wage determination; and

(2) The classification is utilized in the area by the construction industry; and

(3) The proposed wage rate, including any bona fide fringe benefits, bears a reasonable relationship to the wage rates contained in the wage determination.

(b) If the contractor and the laborers and mechanics to be employed in the classification (if known), or their representatives, and HUD or its designee agree on the classification and wage rate (including the amount designated for fringe benefits where appropriate), a report of the action taken shall be sent by HUD or its designee to the Administrator of the Wage and Hour Division, Employment Standards Administration, U.S. Department of Labor, Washington, D.C. 20210. The Administrator, or an authorized representative, will approve, modify, or disapprove every additional classification action within 30 days of receipt and so advise HUD or its designee or will notify HUD or its designee within the 30-day period that additional time is necessary. (Approved by the Office of Management and Budget under OMB control number 1215-0140.)

(c) In the event the contractor, the laborers or mechanics to be employed in the classification or their representatives, and HUD or its designee do not agree on the proposed classification and wage rate (including the amount designated for fringe benefits, where appropriate), HUD or its designee shall refer the questions, including the views of all interested parties and the recommendation of HUD or its designee, to the Administrator for determination. The Administrator, or an authorized representative, will issue a determination within 30 days of receipt and so advise HUD or its designee or will notify HUD or its designee within the 30-day period that additional time is necessary. (Approved by the Office of Management and Budget under OMB Control Number 1215-0140.)

(d) The wage rate (including fringe benefits where appropriate) determined pursuant to subparagraphs (1)(ii)(b) or (c) of this paragraph, shall be paid to all workers performing work in the classification under this contract from the first day on which work is performed in the classification.

(iii) Whenever the minimum wage rate prescribed in the contract for a class of laborers or mechanics includes a fringe benefit which is not expressed as an hourly rate, the contractor shall either pay the benefit as stated in the wage determination or shall pay another bona fide fringe benefit or an hourly cash equivalent thereof.

(iv) If the contractor does not make payments to a trustee or other third person, the contractor may consider as part

of the wages of any laborer or mechanic the amount of any costs reasonably anticipated in providing bona fide fringe benefits under a plan or program, Provided, That the Secretary of Labor has found, upon the written request of the contractor, that the applicable standards of the Davis-Bacon Act have been met. The Secretary of Labor may require the contractor to set aside in a separate account assets for the meeting of obligations under the plan or program. (Approved by the Office of Management and Budget under OMB Control Number 1215-0140.)

2. **Withholding.** HUD or its designee shall upon its own action or upon written request of an authorized representative of the Department of Labor withhold or cause to be withheld from the contractor under this contract or any other Federal contract with the same prime contractor, or any other Federally-assisted contract subject to Davis-Bacon prevailing wage requirements, which is held by the same prime contractor so much of the accrued payments or advances as may be considered necessary to pay laborers and mechanics, including apprentices, trainees and helpers, employed by the contractor or any subcontractor the full amount of wages required by the contract in the event of failure to pay any laborer or mechanic, including any apprentice, trainee or helper, employed or working on the site of the work, all or part of the wages required by the contract, HUD or its designee may, after written notice to the contractor, sponsor, applicant, or owner, take such action as may be necessary to cause the suspension of any further payment, advance, or guarantee of funds until such violations have ceased. HUD or its designee may, after written notice to the contractor, disburse such amounts withheld for and on account of the contractor or subcontractor to the respective employees to whom they are due. The Comptroller General shall make such disbursements in the case of direct Davis-Bacon Act contracts.

3. (l) **Payrolls and basic records.** Payrolls and basic records relating thereto shall be maintained by the contractor during the course of the work preserved for a period of three years thereafter for all laborers and mechanics working at the site of the work. Such records shall contain the name, address, and social security number of each such worker, his or her correct classification, hourly rates of wages paid (including rates of contributions or costs anticipated for bona fide fringe benefits or cash equivalents thereof of the types described in Section 1(b)(2)(B) of the Davis-Bacon Act), daily and weekly number of hours worked, deductions made and actual wages paid. Whenever the Secretary of Labor has found under 29 CFR 5.5 (a)(1)(iv) that the wages of any laborer or mechanic include the amount of any costs reasonably anticipated in providing benefits under a plan or program described in Section 1(b)(2)(B) of the Davis-Bacon Act, the contractor shall maintain records which show that the commitment to provide such benefits is enforceable, that the plan or program is financially responsible, and that the plan or program has been

communicated in writing to the laborers or mechanics affected, and records which show the costs anticipated or the actual cost incurred in providing such benefits. Contractors employing apprentices or trainees under approved programs shall maintain written evidence of the registration of apprenticeship programs and certification of trainee programs, the registration of the apprentices and trainees, and the ratios and wage rates prescribed in the applicable programs. (Approved by the Office of Management and Budget under OMB Control Numbers 1215-0140 and 1215-0017.)

(ll) (a) The contractor shall submit weekly for each week in which any contract work is performed a copy of all payrolls to HUD or its designee if the agency is a party to the contract, but if the agency is not such a party, the contractor will submit the payrolls to the applicant sponsor, or owner, as the case may be, for transmission to HUD or its designee. The payrolls submitted shall set out accurately and completely all of the information required to be maintained under 29 CFR 5.5(a)(3)(l) except that full social security numbers and home addresses shall not be included on weekly transmissions. Instead the payrolls shall only need to include an individually identifying number for each employee (e.g., the last four digits of the employee's social security number). The required weekly payroll information may be submitted in any form desired. Optional Form WH-347 is available for this purpose from the Wage and Hour Division Web site at <http://www.dol.gov/osa/whd/forms/wh347instr.htm> or its successor site. The prime contractor is responsible for the submission of copies of payrolls by all subcontractors. Contractors and subcontractors shall maintain the full social security number and current address of each covered worker, and shall provide them upon request to HUD or its designee if the agency is a party to the contract, but if the agency is not such a party, the contractor will submit the payrolls to the applicant sponsor, or owner, as the case may be, for transmission to HUD or its designee, the contractor, or the Wage and Hour Division of the Department of Labor for purposes of an investigation or audit of compliance with prevailing wage requirements. It is not a violation of this subparagraph for a prime contractor to require a subcontractor to provide addresses and social security numbers to the prime contractor for its own records, without weekly submission to HUD or its designee. (Approved by the Office of Management and Budget under OMB Control Number 1215-0149.)

(b) Each payroll submitted shall be accompanied by a "Statement of Compliance," signed by the contractor or subcontractor or his or her agent who pays or supervises the payment of the persons employed under the contract and shall certify the following:

(1) That the payroll for the payroll period contains the information required to be provided under 29 CFR 5.5 (a)(3)(ll), the appropriate information is being maintained under 29 CFR 5.5(a)(3)(l), and that such information is correct and complete;

(2) That each laborer or mechanic (including each helper, apprentice, and trainee) employed on the contract during the payroll period has been paid the full weekly wages earned, without rebate, either directly or indirectly, and that no deductions have been made either directly or indirectly from the full wages earned, other than permissible deductions as set forth in 29 CFR Part 3;

(3) That each laborer or mechanic has been paid not less than the applicable wage rates and fringe benefits or cash equivalents, for the classification of work performed, as specified in the applicable wage determination incorporated into the contract.

(c) The weekly submission of a properly executed certification set forth on the reverse side of Optional Form WH-347 shall satisfy the requirement for submission of the "Statement of Compliance" required by subparagraph A.3.(i)(b).

(d) The falsification of any of the above certifications may subject the contractor or subcontractor to civil or criminal prosecution under Section 1001 of Title 18 and Section 231 of Title 31 of the United States Code.

(iii) The contractor or subcontractor shall make the records required under subparagraph A.3.(i) available for inspection, copying, or transcription by authorized representatives of HUD or its designee or the Department of Labor, and shall permit such representatives to interview employees during working hours on the job. If the contractor or subcontractor fails to submit the required records or to make them available, HUD or its designee may, after written notice to the contractor, sponsor, applicant or owner, take such action as may be necessary to cause the suspension of any further payment, advance, or guarantee of funds. Furthermore, failure to submit the required records upon request or to make such records available may be grounds for debarment action pursuant to 29 CFR 5.12.

4. Apprentices and Trainees.

(i) Apprentices. Apprentices will be permitted to work at less than the predetermined rate for the work they performed when they are employed pursuant to and individually registered in a bona fide apprenticeship program registered with the U.S. Department of Labor, Employment and Training Administration, Office of Apprenticeship Training, Employer and Labor Services, or with a State Apprenticeship Agency recognized by the Office, or if a person is employed in his or her first 90 days of probationary employment as an apprentice in such an apprenticeship program, who is not individually registered in the program, but who has been certified by the Office of Apprenticeship Training, Employer and Labor Services or a State Apprenticeship Agency (where appropriate) to be eligible for probationary employment as an apprentice. The allowable ratio of apprentices to journeymen on the job site in any craft classification shall not be greater than the ratio permitted to the contractor as to the entire work force under the registered program. Any worker listed on a payroll at an apprentice wage rate, who

is not registered or otherwise employed as stated above, shall be paid not less than the applicable wage rate on the wage determination for the classification of work actually performed. In addition, any apprentice performing work on the job site in excess of the ratio permitted under the registered program shall be paid not less than the applicable wage rate on the wage determination for the work actually performed. Where a contractor is performing construction on a project in a locality other than that in which its program is registered, the ratios and wage rates (expressed in percentages of the journeyman's hourly rate) specified in the contractor's or subcontractor's registered program shall be observed. Every apprentice must be paid at not less than the rate specified in the registered program for the apprentice's level of progress, expressed as a percentage of the journeymen hourly rate specified in the applicable wage determination. Apprentices shall be paid fringe benefits in accordance with the provisions of the apprenticeship program. If the apprenticeship program does not specify fringe benefits, apprentices must be paid the full amount of fringe benefits listed on the wage determination for the applicable classification. If the Administrator determines that a different practice prevails for the applicable apprentice classification, fringes shall be paid in accordance with that determination. In the event the Office of Apprenticeship Training, Employer and Labor Services, or a State Apprenticeship Agency recognized by the Office, withdraws approval of an apprenticeship program, the contractor will no longer be permitted to utilize apprentices at less than the applicable predetermined rate for the work performed until an acceptable program is approved.

(ii) Trainees. Except as provided in 29 CFR 5.16, trainees will not be permitted to work at less than the predetermined rate for the work performed unless they are employed pursuant to and individually registered in a program which has received prior approval, evidenced by formal certification by the U.S. Department of Labor, Employment and Training Administration. The ratio of trainees to journeymen on the job site shall not be greater than permitted under the plan approved by the Employment and Training Administration. Every trainee must be paid at not less than the rate specified in the approved program for the trainee's level of progress, expressed as a percentage of the journeyman hourly rate specified in the applicable wage determination. Trainees shall be paid fringe benefits in accordance with the provisions of the trainee program. If the trainee program does not mention fringe benefits, trainees shall be paid the full amount of fringe benefits listed on the wage determination unless the Administrator of the Wage and Hour Division determines that there is an apprenticeship program associated with the corresponding journeyman wage rate on the wage determination which provides for less than full fringe benefits for apprentices. Any employee listed on the payroll at a trainee rate who is not registered and participating in a training plan approved by

the Employment and Training Administration shall be paid not less than the applicable wage rate on the wage determination for the work actually performed. In addition, any trainee performing work on the job site in excess of the ratio permitted under the registered program shall be paid not less than the applicable wage rate on the wage determination for the work actually performed. In the event the Employment and Training Administration withdraws approval of a training program, the contractor will no longer be permitted to utilize trainees at less than the applicable predetermined rate for the work performed until an acceptable program is approved.

(III) Equal employment opportunity. The utilization of apprentices, trainees and journeymen under 29 CFR Part 5 shall be in conformity with the equal employment opportunity requirements of Executive Order 11246, as amended, and 29 CFR Part 30.

5. Compliance with Copeland Act requirements. The contractor shall comply with the requirements of 29 CFR Part 3 which are incorporated by reference in this contract.

6. Subcontracts. The contractor or subcontractor will insert in any subcontracts the clauses contained in subparagraphs 1 through 11 in this paragraph A and such other clauses as HUD or its designee may by appropriate instructions require, and a copy of the applicable prevailing wage decision, and also a clause requiring the subcontractors to include these clauses in any lower tier subcontracts. The prime contractor shall be responsible for the compliance by any subcontractor or lower tier subcontractor with all the contract clauses in this paragraph.

7. Contract termination; debarment. A breach of the contract clauses in 29 CFR 5.5 may be grounds for termination of the contract and for debarment as a contractor and a subcontractor as provided in 29 CFR 5.12.

8. Compliance with Davis-Bacon and Related Act Requirements. All rulings and interpretations of the Davis-Bacon and Related Acts contained in 29 CFR Parts 1, 3, and 5 are herein incorporated by reference in this contract.

9. Disputes concerning labor standards. Disputes arising out of the labor standards provisions of this contract shall not be subject to the general disputes clause of this contract. Such disputes shall be resolved in accordance with the procedures of the Department of Labor set forth in 29 CFR Parts 5, 6, and 7. Disputes within the meaning of this clause include disputes between the contractor (or any of its subcontractors) and HUD or its designee, the U.S. Department of Labor, or the employees or their representatives.

10. (I) Certification of Eligibility. By entering into this contract the contractor certifies that neither it (nor he or she) nor any person or firm who has an interest in the contractor's firm is a person or firm ineligible to be awarded Government contracts by virtue of Section 3(a) of the Davis-Bacon Act or 29 CFR 5.12(a)(1) or to be

awarded HUD contracts or participate in HUD programs pursuant to 24 CFR Part 24.

(II) No part of this contract shall be subcontracted to any person or firm ineligible for award of a Government contract by virtue of Section 3(a) of the Davis-Bacon Act or 29 CFR 5.12(a)(1) or to be awarded HUD contracts or participate in HUD programs pursuant to 24 CFR Part 24.

(III) The penalty for making false statements is prescribed in the U.S. Criminal Code, 18 U.S.C. 1001. Additionally, U.S. Criminal Code, Section 1010, Title 18, U.S.C., "Federal Housing Administration transactions", provides in part: "Whoever, for the purpose of . . . influencing in any way the action of such Administration . . . makes, utters or publishes any statement knowing the same to be false . . . shall be fined not more than \$5,000 or imprisoned not more than two years, or both."

11. Complaints, Proceedings, or Testimony by Employees. No laborer or mechanic to whom the wage, salary, or other labor standards provisions of this Contract are applicable shall be discharged or in any other manner discriminated against by the Contractor or any subcontractor because such employee has filed any complaint or instituted or caused to be instituted any proceeding or has testified or is about to testify in any proceeding under or relating to the labor standards applicable under this Contract to his employer.

B. Contract Work Hours and Safety Standards Act. The provisions of this paragraph B are applicable where the amount of the prime contract exceeds \$100,000. As used in this paragraph, the terms "laborers" and "mechanics" include watchmen and guards.

(1) Overtime requirements. No contractor or subcontractor contracting for any part of the contract work which may require or involve the employment of laborers or mechanics shall require or permit any such laborer or mechanic in any workweek in which the individual is employed on such work to work in excess of 40 hours in such workweek unless such laborer or mechanic receives compensation at a rate not less than one and one-half times the basic rate of pay for all hours worked in excess of 40 hours in such workweek.

(2) Violation; liability for unpaid wages; liquidated damages. In the event of any violation of the clause set forth in subparagraph (1) of this paragraph, the contractor and any subcontractor responsible therefor shall be liable for the unpaid wages. In addition, such contractor and subcontractor shall be liable to the United States (in the case of work done under contract for the District of Columbia or a territory, to such District or to such territory), for liquidated damages. Such liquidated damages shall be computed with respect to each individual laborer or mechanic, including watchmen and guards, employed in violation of the clause set forth in subparagraph (1) of this paragraph, in the sum of \$10 for each calendar day on which such individual was required or permitted to work in excess of the standard workweek of 40 hours without payment of the overtime wages required by the clause set forth in subparagraph (1) of this paragraph.

(3) Withholding for unpaid wages and liquidated damages. HUD or its designee shall upon its own action or upon written request of an authorized representative of the Department of Labor withhold or cause to be withheld, from any moneys payable on account of work performed by the contractor or subcontractor under any such contract or any other Federal contract with the same prime contract, or any other Federally-assisted contract subject to the Contract Work Hours and Safety Standards Act which is held by the same prime contractor such sums as may be determined to be necessary to satisfy any liabilities of such contractor or subcontractor for unpaid wages and liquidated damages as provided in the clause set forth in subparagraph (2) of this paragraph.

(4) Subcontracts. The contractor or subcontractor shall insert in any subcontracts the clauses set forth in subparagraph (1) through (4) of this paragraph and also a clause requiring the subcontractors to include these clauses in any lower tier subcontracts. The prime contractor shall be responsible for compliance by any subcontractor or lower tier subcontractor with the clauses set forth in subparagraphs (1) through (4) of this paragraph.

C. Health and Safety. The provisions of this paragraph C are applicable where the amount of the prime contract exceeds \$100,000.

(1) No laborer or mechanic shall be required to work in surroundings or under working conditions which are unsanitary, hazardous, or dangerous to his health and safety as determined under construction safety and health standards promulgated by the Secretary of Labor by regulation.

(2) The Contractor shall comply with all regulations issued by the Secretary of Labor pursuant to Title 29 Part 1926 and failure to comply may result in imposition of sanctions pursuant to the Contract Work Hours and Safety Standards Act, (Public Law 91-54, 83 Stat 96). 40 USC 3701 et seq.

(3) The contractor shall include the provisions of this paragraph in every subcontract so that such provisions will be binding on each subcontractor. The contractor shall take such action with respect to any subcontractor as the Secretary of Housing and Urban Development or the Secretary of Labor shall direct as a means of enforcing such provisions.

/

**CERTIFICATE OF COMPLIANCE WITH FEDERAL LABOR STANDARDS
PROVISIONS**

I, the undersigned _____, the duly authorized representative of _____ (hereinafter referred to as the contractor), do hereby certify that I have examined the Federal Labor Standards Provisions (HD-4010) with related certificates and documents, and all of the conditions surrounding these provisions including, but not limited to the following:

1. The contractor is responsible for employing only eligible subcontractors who have certified eligibility in written contract containing Federal Labor Standards Provisions;
2. The contractor is responsible for the payment of Federal prevailing wage rates by its subcontractors while performing work under this contract. If the subcontractor fails to pay the prevailing wages as specified in this contract, the prime contractor may be required to make appropriate restitution to the underpaid workers;
3. The contractor is responsible for collecting weekly certified payrolls from its subcontractors, reviewing said payrolls for compliance with the Federal wage rates, and forward same to the local government contract authority; and
4. The contractor also understands that only those classifications listed in the original bid documents are applicable to this job, and no special classifications may be incorporated after contract award.

The prime contractor hereby agrees to perform all of its responsibilities in conformance with the Federal Labor Standards Provisions both diligently and effectively.

BY: _____ DATE: _____

TITLE: _____

**COMMUNITY DEVELOPMENT BLOCK GRANT PROGRAM
CONTRACTOR'S CERTIFICATION CONCERNING LABOR STANDARDS
AND PREVAILING WAGE REQUIREMENTS**

To (Appropriate Recipient): _____ Date: _____

Project No. (if any) _____

c/o _____ Project Name: _____

1. The undersigned, having executed a contract with _____ for the construction of the above-identified project, acknowledges that:
- a. The Labor Standards provisions are included in the aforesaid contract.
 - b. Correction of any infractions of the aforesaid condition, including infractions by any of his subcontractors and any lower tier subcontractors, is his responsibility.

2. He certifies that:

- a. Neither he nor any firm, partnership, or association in which he has substantial interest is designated as an ineligible contractor by the Comptroller General of the United States pursuant to Section 5.6(b) of the Regulations of the Secretary of Labor, Part 5 (29 CFR, Part 5) or pursuant to Section 3(a) of the Davis-Bacon Act, as amended (40 U.S.C. 476a-2(a)).
- b. No part of the aforementioned contract has been or will be subcontracted to any subcontractor if each subcontractor or any firm, corporation, partnership or association in which such subcontractor has a substantial interest is designated as an ineligible contractor pursuant to any of the aforementioned regulatory or statutory provisions.

3. He agrees to obtain and forward to the aforementioned recipient within ten days after the execution of any subcontract, including those executed by his subcontractors and any lower tier subcontractors, a Subcontractor's Certification Concerning Labor Standards and Prevailing Wage Requirements executed by the subcontractors.

4. He certifies that:

- a. The legal name and the business address of the undersigned are:

b. The undersigned is:

- | | |
|----------------------------|--|
| 1. A SINGLE PROPRIETORSHIP | 2. A CORPORATION ORGANIZED IN THE STATE OF |
| 3. A PARTNERSHIP | 4. OTHER ORGANIZATION (Describe) |

c. The name, title and address of the owner, partners or officers of the undersigned are:

NAME	TITLE	ADDRESS
------	-------	---------

d. The names and addresses of all other persons, both natural and corporate, having a substantial interest in the undersigned, and the nature of the interest are (if none, so state):

NAME	ADDRESS	NATURE OF INTEREST
------	---------	--------------------

e. The names, addresses and trade classifications of all other building construction contractors in which the undersigned has a substantial interest are (if none, so state):

NAME	ADDRESS	TRADE CLASSIFICATION
------	---------	----------------------

(Contractor)

BY: _____
(Signature)

Date

WARNING

U.S. Criminal Code, section 1010, Title 18, U.S.C., provides in part: "Whoever...makes, passes, writes or publishes any statement, knowing the same to be false...shall be fined not more than \$5,000 or imprisoned not more than two years, or more."

**COMMUNITY DEVELOPMENT BLOCK GRANT PROGRAM
SUBCONTRACTOR'S CERTIFICATION
CONCERNING LABOR STANDARDS AND PREVAILING WAGE
REQUIREMENTS**

To (Appropriate Recipient): _____ Date: _____

Project No. (if any) _____

c/o _____ Project Name: _____

1. The undersigned, having executed a contract with _____
(Contractor or Subcontractor)

for _____
(Nature of Work)

in the amount of \$ _____ in the construction of the above-identified project, certifies that:

- a. The Labor Standards Provisions of the Contract for Construction are included in the aforesaid contract.
- b. Neither he nor any firm, corporation, partnership, or association in which he has a substantial interest is designated as an ineligible contractor by the Comptroller General of the United States pursuant to Section 5.6(b) of the Regulations of the Secretary of Labor, Part 5 (29 CFR, Part 5), or pursuant to Section 3(a) of the Davis-Bacon Act, as amended (40 U.S.C. 276a-2(a)).
- c. No part of the aforementioned contract has been or will be subcontracted to any subcontractor if such subcontractor or any firm, corporation, partnership, or association in which such subcontractor has a substantial interest is designated as ineligible contractor pursuant to the aforesaid regulatory or statutory provisions.

2. He agrees to obtain and forward to the contractor, for transmittal to the recipient, within ten days after the execution of any lower subcontract, a Subcontractor's Certification Concerning Labor Standards and Prevailing Wage Requirements, executed by the lower tier subcontractor, in duplicate.

a. The workman will report for duty on or about _____
(date)

3. He certifies that:

a. The legal name and the business address of the undersigned are:

b. The undersigned is:

- | | |
|----------------------------|--|
| 1. A SINGLE PROPRIETORSHIP | 2. A CORPORATION ORGANIZED IN THE STATE OF |
| 3. A PARTNERSHIP | 4. OTHER ORGANIZATION (Describe) |

c. The name, title and address of the owner, partners or officers of the undersigned are:

NAME	TITLE	ADDRESS
------	-------	---------

d. The names and addresses of all other persons, both natural and corporate, having a substantial interest in the undersigned, and the nature of the interest are (if none, so state):

NAME	ADDRESS	NATURE OF INTEREST
------	---------	--------------------

e. The names, addresses and trade classifications of all other building construction contractors in which the undersigned has a substantial interest are (if none, so state):

NAME	ADDRESS	TRADE CLASSIFICATION
------	---------	----------------------

(Subcontractor)

BY: _____
(Signature)

Date

WARNING

U.S. Criminal Code, section 1010, Title 18, U.S.C., provides in part: "Whoever...makes, passes, writes or publishes any statement, knowing the same to be false...shall be fined not more than \$5,000 or imprisoned not more than two years, or more."

SECTION IX
PREVAILING WAGE DATA

Federal Davis-Bacon Wage Decision

<https://beta.sam.gov/search?index=wd&keywords=&sort=-modifiedDate&wdType=dbra&page=1>
https://beta.sam.gov/search/?index=dbra&page=1&sort=-modifiedDate&sfm%5Bstatus%5D%5Bis_active%5D=true

(input state, county, heavy, click on the Davis Bacon Act WD # OH20210001 (for example)

"General Decision Number: OH20210001 04/30/2021

Superseded General Decision Number: OH20200001

State: Ohio

Construction Types: Heavy and Highway

Counties: Ohio Statewide.

Heavy and Highway Construction Projects

Note: Under Executive Order (EO) 13658, an hourly minimum wage of \$10.95 for calendar year 2021 applies to all contracts subject to the Davis-Bacon Act for which the contract is awarded (and any solicitation was issued) on or after January 1, 2015. If this contract is covered by the EO, the contractor must pay all workers in any classification listed on this wage determination at least \$10.95 per hour (or the applicable wage rate listed on this wage determination, if it is higher) for all hours spent performing on the contract in calendar year 2021. If this contract is covered by the EO and a classification considered necessary for performance of work on the contract does not appear on this wage determination, the contractor must pay workers in that classification at least the wage rate determined through the conformance process set forth in 29 CFR 5.5(a)(1)(ii) (or the EO minimum wage rate, if it is higher than the conformed wage rate). The EO minimum wage rate will be adjusted annually. Please note that this EO applies to the above-mentioned types of contracts entered into by the federal government that are subject to the Davis-Bacon Act itself, but it does not apply to contracts subject only to the Davis-Bacon Related Acts, including those set forth at 29 CFR 5.1(a)(2)-(60). Additional information on contractor requirements and worker protections under the EO is available at www.dol.gov/whd/govcontracts.

Modification Number	Publication Date
0	01/01/2021
1	01/22/2021
2	02/12/2021
3	04/23/2021
4	04/30/2021

BROH0001-001 06/01/2019

DEFIANCE, FULTON (Excluding Fulton, Amboy & Swan Creek Townships), HENRY (Excluding Monroe, Bartlow, Liberty, Washington, Richfield, Marion, Damascus & Townships & that part of Harrison Township outside corporate limits of city of Napoleon), PAULDING, PUTNAM and WILLIAMS COUNTIES

Rates

Fringes

Bricklayer, Stonemason.....\$ 29.34 16.11

BROH0001-004 06/01/2019

Rates Fringes

CEMENT MASON/CONCRETE FINISHER...\$ 29.34 16.11

BROH0003-002 06/01/2019

FULTON (Townships of Amboy, Swan Creek & Fulton), HENRY (Townships of Washington, Damascus, Richfield, Bartlow, Liberty, Harrison, Monroe, & Marion), LUCAS and WOOD (Townships of Perrysburg, Ross, Lake, Troy, Freedom, Montgomery, Webster, Center, Portage, Middleton, Plain, Liberty, Henry, Washington, Weston, Milton, Jackson & Grand Rapids) COUNTIES

Rates Fringes

Bricklayer, Stonemason.....\$ 29.34 16.11

BROH0005-003 06/01/2020

CUYAHOGA, LORAIN & MEDINA (Hinckley, Granger, Brunswick, Liverpool, Montville, York, Homer, Harrisville, Chatham, Litchfield & Spencer Townships and the city of Medina)

Rates Fringes

BRICKLAYER

BRICKLAYERS; CAULKERS;
CLEANERS; POINTERS; &
STONEMASONS.....\$ 36.64 17.13
SANDBLASTERS.....\$ 36.39 17.13
SEWER BRICKLAYERS & STACK
BUILDERS.....\$ 36.64 17.13
SWING SCAFFOLDS.....\$ 37.14 17.13

BROH0006-005 06/01/2019

CARROLL, COLUMBIANA (Knox, Butler, West & Hanover Townships), STARK & TUSCARAWAS

Rates Fringes

Bricklayer, Stonemason.....\$ 29.34 16.11

BROH0007-002 06/01/2019

LAWRENCE

Rates Fringes

Bricklayer, Stonemason.....\$ 29.34 16.11

BROH0007-005 06/01/2019

PORTAGE & SUMMIT

	Rates	Fringes
BRICKLAYER.....	\$ 29.34	16.11

 BROH0007-010 06/01/2019

PORTAGE & SUMMIT

	Rates	Fringes
MASON - STONE.....	\$ 29.34	16.11

 BROH0008-001 06/01/2019

COLUMBIANA (Salem, Perry, Fairfield, Center, Elk Run, Middleton, & Unity Townships and the city of New Waterford), MAHONING & TRUMBULL

	Rates	Fringes
BRICKLAYER.....	\$ 29.34	16.11

 BROH0009-002 06/01/2019

BELMONT & MONROE COUNTIES and the Townships of Warren & Mt. Pleasant and the Village of Dillonvale in JEFFERSON COUNTY

	Rates	Fringes
Bricklayer, Stonemason.....	\$ 29.34	16.11
Refractory.....	\$ 31.45	19.01

 BROH0010-002 06/01/2019

COLUMBIANA (St. Clair, Madison, Wayne, Franklin, Washington, Yellow Creek & Liverpool Townships) & JEFFERSON (Brush Creek & Saline Townships)

	Rates	Fringes
Bricklayer, Stonemason.....	\$ 29.34	16.11

 BROH0014-002 06/01/2019

HARRISON & JEFFERSON (Except Mt. Pleasant, Warren, Brush Creek, Saline & Salineville Townships & the Village of Dillonvale)

	Rates	Fringes
Bricklayer, Stonemason.....	\$ 29.34	16.11

 BROH0016-002 06/01/2019

ASHTABULA, GEAUGA, and LAKE COUNTIES

Rates	Fringes
-------	---------

Bricklayer, Stonemason.....\$ 29.34 16.11

BROH0018-002 06/01/2019

BROWN, BUTLER, CLERMONT, HAMILTON, PREBLE (Gasper, Dixon, Israel, Lanier, Somers & Gratis Townships) & WARREN COUNTIES:

Rates Fringes

Bricklayer, Stonemason.....\$ 29.34 16.11

BROH0022-004 06/01/2019

CHAMPAIGN, CLARK, CLINTON, DARKE, GREENE, HIGHLAND, LOGAN, MIAMI, MONTGOMERY, PREBLE (Jackson, Monroe, Harrison, Twin, Jefferson & Washington Townships) and SHELBY COUNTIES

Rates Fringes

Bricklayer, Stonemason.....\$ 29.34 16.11

BROH0032-001 06/01/2019

GALLIA & MEIGS

Rates Fringes

Bricklayer, Stonemason.....\$ 29.34 16.11

BROH0035-002 06/01/2019

ALLEN, AUGLAIZE, MERCER and VAN WERT COUNTIES

Rates Fringes

Bricklayer, Stonemason.....\$ 29.34 16.11

BROH0039-002 06/01/2019

ADAMS & SCIOTO

Rates Fringes

Bricklayer, Stonemason.....\$ 29.34 16.11

BROH0040-003 06/01/2019

ASHLAND, CRAWFORD, HARDIN, HOLMES, MARION, MORROW, RICHLAND, WAYNE and WYANDOT (Except Crawford, Ridge, Richland & Tymochtee Townships) COUNTIES

Rates Fringes

Bricklayer, Stonemason.....\$ 29.34 16.11

FOOTNOTE: Layout Man and Sawman rate: \$1.00 per hour above journeyman rate.
Free standing stack work ground level to top of stack;
Sandblasting and laying of carbon masonry material in swing

stage and/or scaffold; Ramming and spading of plastics and
 gunniting: \$1.50 per hour above journeyman rate.
 ""Hot"" work: \$2.50 above journeyman rate.

 BROH0044-002 06/01/2019

	Rates	Fringes
Bricklayer, Stonemason COSHOCTON, FAIRFIELD, GUERNSEY, HOCKING, KNOX, KICKING, MORGAN, MUSKINGUM, NOBLE (Beaver, Buffalo, Seneca & Wayne Townships) & PERRY COUNTIES:.....	\$ 29.34	16.11

 BROH0045-002 06/01/2017

FAYETTE, JACKSON, PIKE, ROSS and VINTON COUNTIES

	Rates	Fringes
Bricklayer, Stonemason.....	\$ 28.65	14.55

 BROH0046-002 06/01/2019

ERIE, HANCOCK, HURON, OTTAWA, SANDUSKY, SENECA, WOOD (Perry &
 Bloom Townships) and WYANDOT (Tymochtee, Crawford, Ridge &
 Richland Townships) COUNTIES & the Islands of Lake Erie north
 of Sandusky

	Rates	Fringes
Bricklayer, Stonemason.....	\$ 29.34	16.11

FOOTNOTE: Layout Man and Sawman rate: \$1.00 per hour above
 journeyman rate.
 Free standing stack work ground level to top of stack;
 Sandblasting and laying of carbon masonry material in swing
 stage and/or scaffold; Ramming and spading of plastics and
 gunniting: \$1.50 per hour above journeyman rate.
 ""Hot"" work: \$2.50 above journeyman rate.

 BROH0052-001 06/01/2019

ATHENS COUNTY

	Rates	Fringes
Bricklayer, Stonemason.....	\$ 29.34	16.11

 BROH0052-003 06/01/2019

NOBLE (Brookfield, Noble, Center, Sharon, Olive, Enoch, Stock,
 Jackson, Jefferson & Elk Townships) and WASHINGTON COUNTIES

	Rates	Fringes
--	-------	---------

Bricklayer, Stonemason.....\$ 29.34 16.11

BROH0055-003 06/01/2017

DELAWARE, FRANKLIN, MADISON, PICKAWAY and UNION COUNTIES

Rates Fringes

Bricklayer, Stonemason.....\$ 28.65 14.55

CARP0003-004 05/01/2017

MAHONING & TRUMBULL

Rates Fringes

CARPENTER.....\$ 26.20 17.42

CARP0069-003 05/01/2017

CARROLL, STARK, TUSCARAWAS & WAYNE

Rates Fringes

CARPENTER.....\$ 25.98 15.98

CARP0069-006 05/01/2017

COSHOCTON, HOLMES, KNOX & MORROW

Rates Fringes

CARPENTER.....\$ 24.04 15.29

CARP0171-002 05/01/2019

BELMONT, COLUMBIANA, HARRISON, JEFFERSON & MONROE

Rates Fringes

CARPENTER.....\$ 27.37 20.02

CARP0200-002 05/01/2017

ADAMS, ATHENS, DELAWARE, FAIRFIELD, FAYETTE, FRANKLIN, GALLIA,
GUERNSEY, HIGHLAND, HOCKING, JACKSON, LAWRENCE, LICKING,
MADISON, MARION, MEIGS, MORGAN, MUSKINGUM, NOBLE, PERRY,
PICKAWAY, PIKE, ROSS, SCIOTO, UNION, VINTON and WASHINGTON
COUNTIES

Rates Fringes

CARPENTER.....\$ 29.07 16.22

Diver.....\$ 39.41 10.40

PILEDRIVERMAN.....\$ 29.07 16.22

CARP0248-005 07/01/2008

LUCAS & WOOD

	Rates	Fringes
CARPENTER.....	\$ 27.27	14.58

CARP0248-008 07/01/2008

	Rates	Fringes
CARPENTER DEFIANCE, FULTON, HANCOCK, HENRY, PAULDING & WILLIAMS COUNTIES.....	\$ 23.71	13.28

CARP0254-002 05/01/2017

ASHTABULA, CUYAHOGA, GEAUGA & LAKE

	Rates	Fringes
CARPENTER.....	\$ 32.40	16.97

CARP0372-002 05/01/2016

ALLEN, AUGLAIZE, HARDIN, MERCER, PUTNAM & VAN WERT

	Rates	Fringes
CARPENTER.....	\$ 24.54	18.21

CARP0639-003 05/01/2017

MEDINA, PORTAGE & SUMMIT

	Rates	Fringes
CARPENTER.....	\$ 30.42	16.99

CARP0735-002 05/01/2019

ASHLAND, ERIE, HURON, LORAIN & RICHLAND

	Rates	Fringes
CARPENTER.....	\$ 26.30	17.91

CARP1311-001 05/01/2017

BROWN, BUTLER, CHAMPAIGN, CLARK, CLERMONT, CLINTON, DARKE,
GREENE, HAMILTON, LOGAN, MIAMI, MONTGOMERY, PREBLE, SHELBY &
WARREN

	Rates	Fringes
Carpenter & Piledrivermen.....	\$ 29.34	15.95
Diver.....	\$ 40.58	9.69

CARP1393-002 07/01/2008

CRAWFORD, DEFIANCE, FULTON, HANCOCK, HENRY, LUCAS, OTTAWA,
PAULDING, SANDUSKY, SENECA, WILLIAMS & WOOD

	Rates	Fringes
Piledrivermen & Diver's Tender...	\$ 27.30	16.05

DIVERS - \$250.00 per day

 CARP1393-003 07/01/2008

ALLEN, AUGLAIZE, HARDIN, MERCER, PUTNAM, VAN WERT & WYANDOT

	Rates	Fringes
Piledrivermen & Diver's Tender...	\$ 25.15	15.92

DIVERS - \$250.00 per day

 CARP1871-006 05/01/2017

BELMONT, HARRISON, & MONROE

	Rates	Fringes
Diver, Wet.....	\$ 48.11	17.33
Piledrivermen; Diver, Dry.....	\$ 32.07	17.33

 CARP1871-008 05/01/2017

ASHLAND, ASHTABULA, CUYAHOGA, ERIE, GEAUGA, HURON, LAKE,
 LORAIN, MEDINA, PORTAGE, RICHLAND & SUMMIT

	Rates	Fringes
Diver, Wet.....	\$ 45.80	18.84
Piledrivermen; Diver, Dry.....	\$ 30.53	18.84

 CARP1871-014 05/01/2017

CARROLL, STARK, TUSCARAWAS & WAYNE

	Rates	Fringes
Diver, Wet.....	\$ 38.34	16.95
Piledrivermen; Diver, Dry.....	\$ 25.56	16.95

 CARP1871-015 05/01/2017

COSHOCTON, HOLMES, KNOX & MORROW

	Rates	Fringes
Diver, Wet.....	\$ 37.34	16.07
Piledrivermen; Diver, Dry.....	\$ 24.89	16.07

 CARP1871-017 05/01/2017

MAHONING & TRUMBULL

	Rates	Fringes
Diver, Wet.....	\$ 40.65	17.62

Piledrivermen; Diver, Dry.....\$ 27.10 17.62

CARP2235-012 01/01/2014

COLUMBIANA & JEFFERSON

	Rates	Fringes
PILEDRIVERMAN.....	\$ 31.74	16.41

CARP2239-001 07/01/2008

CRAWFORD, OTTAWA, SANDUSKY, SENECA & WYANDOT

	Rates	Fringes
CARPENTER.....	\$ 23.71	13.28

ELEC0008-002 05/25/2020

DEFIANCE, FULTON, HANCOCK, HENRY, LUCAS, OTTAWA, PAULDING,
PUTNAM, SANDUSKY, SENECA, WILLIAMS & WOOD

	Rates	Fringes
CABLE SPLICER.....	\$ 38.98	18.96
ELECTRICIAN.....	\$ 41.81	4.5%+20.73

ELEC0032-003 11/29/2020

ALLEN, AUGLAIZE, HARDIN, LOGAN, MERCER, SHELBY, VAN WERT &
WYANDOT (Crawford, Jackson, Marseilles, Mifflin, Ridgeland,
Ridge & Salem Townships)

	Rates	Fringes
ELECTRICIAN.....	\$ 32.12	20.29

ELEC0038-002 04/27/2020

CUYAHOGA, GEAUGA (Bainbridge, Chester & Russell Townships) &
LORAIN (Columbia Township)

	Rates	Fringes
ELECTRICIAN Excluding Sound & Communications Work.....	\$ 39.88	21.22

FOOTNOTES;

- a. 6 Paid Holidays: New Year's Day; Memorial Day; July 4th;
Labor Day; Thanksgiving Day; & Christmas Day
- b. 1 week's paid vacation for 1 year's service; 2 weeks' paid
vacation for 2 or more years' service

ELEC0038-008 04/29/2019

CUYAHOGA, GEAUGA (Bainbridge, Chester & Russell Townships) &

LORAIN (Columbia Township)

	Rates	Fringes
Sound & Communication Technician		
Communications Technician...\$ 27.55		11.98
Installer Technician.....\$ 26.30		11.94

FOOTNOTES;

- a. 6 Paid Holidays: New Year's Day; Memorial Day; July 4th; Labor Day; Thanksgiving Day; & Christmas Day
- b. 1 week's paid vacation for 1 year's service; 2 weeks' paid vacation for 2 or more years' service

 ELEC0064-003 11/30/2020

COLUMBIANA (Butler, Fairfield, Perry, Salem & Unity Townships)
 MAHONING (Austintown, Beaver, Berlin, Boardman, Canfield, Ellsworth, Coitsville, Goshen, Green, Jackson, Poland, Springfield & Youngstown Townships), & TRUMBULL (Hubbard & Liberty Townships)

	Rates	Fringes
ELECTRICIAN.....\$ 35.67		16.37

 ELEC0071-001 01/01/2019

ASHLAND, CHAMPAIGN, CLARK, COSHOCTON, CRAWFORD, DELAWARE, FAIRFIELD, FAYETTE, FRANKLIN, GUERNSEY, HIGHLAND, HOCKING, JACKSON (Coal, Jackson, Liberty, Milton, Washington & Wellston Townships), KNOX, LICKING, MADISON, MARION, MONROE, MORGAN, MORROW, MUSKINGUM, NOBLE, PERRY, PICKAWAY, PIKE (Beaver, Benton, Jackson, Mifflin, Pebble, Peepee, Perry & Seal Townships), RICHLAND, ROSS, TUSCARAWAS (Auburn, Bucks, Clay, Jefferson, Oxford, Perry, Salem, Rush, Washington & York Townships), UNION, VINTON (Clinton, Eagle, Elk, Harrison, Jackson, Richland & Swan Townships), and WASHINGTON COUNTIES

	Rates	Fringes
Line Construction		
Equipment Operators.....\$ 33.62		13.40
Groundmen.....\$ 24.17		11.32
Linemen & Cable Splicers....\$ 38.27		14.42

 ELEC0071-004 01/01/2019

AUGLAIZE, CLINTON, DARKE, GREENE, LOGAN, MERCER, MIAMI, MONTGOMERY, PREBLE, and SHELBY COUNTIES

	Rates	Fringes
Line Construction		
Equipment Operator.....\$ 33.62		13.40
Groundman.....\$ 24.17		11.32

Lineman & Cable Splicers....\$ 38.27 14.42

ELEC0071-005 12/31/2018

ASHTABULA, CUYAHOGA, GEAUGA, LAKE & LORAIN

Rates Fringes

LINE CONSTRUCTION: Equipment Operator

DOT/Traffic Signal & Highway Lighting Projects...\$ 32.44 14.10
Municipal Power/Transit Projects.....\$ 40.10 16.42

LINE CONSTRUCTION: Groundman

DOT/Traffic Signal & Highway Lighting Projects...\$ 25.06 12.26
Municipal Power/Transit Projects.....\$ 31.19 14.11

LINE CONSTRUCTION:

Linemen/Cable Splicer

DOT/Traffic Signal & Highway Lighting Projects...\$ 36.13 15.03
Municipal Power/Transit Projects.....\$ 44.56 17.58

ELEC0071-008 01/01/2019

COLUMBIANA, MAHONING, and TRUMBULL COUNTIES

Rates Fringes

Line Construction

Equipment Operator.....\$ 33.62 13.40
Groundman.....\$ 24.17 11.32
Lineman & Cable Splicers....\$ 38.27 14.42

ELEC0071-010 01/01/2019

BELMONT, CARROLL, HARRISON, HOLMES, JEFFERSON, MEDINA, PORTAGE, STARK, SUMMIT, and WAYNE COUNTIES

Rates Fringes

Line Construction

Equipment Operator.....\$ 33.62 13.40
Groundman.....\$ 24.17 11.32
Lineman & Cable Splicers....\$ 38.27 14.42

ELEC0071-013 01/01/2019

BROWN, BUTLER, CLERMONT, HAMILTON, and WARREN COUNTIES

Rates Fringes

Line Construction

Equipment Operator.....\$ 33.62 13.40
Groundman.....\$ 24.17 11.32
Lineman & Cable Splicers....\$ 38.27 14.42

ELEC0071-014 01/01/2019

ADAMS, ATHENS, GALLIA, JACKSON (Bloomfield, Franklin, Hamilton, Lick, Jefferson, Scioto & Madison Townships), LAWRENCE, MEIGS, PIKE (Camp Creek, Marion, Newton, Scioto, Sunfish & Union Townships), SCIOTO & VINTON (Brown, Knox, Madison, Vinton & Wilkesville Townships)

	Rates	Fringes
Line Construction		
Equipment Operator.....	\$ 33.62	13.40
Groundman.....	\$ 24.17	11.32
Lineman & Cable Splicers....	\$ 38.27	14.42

ELEC0082-002 11/30/2020

CLINTON, DARKE, GREENE, MIAMI, MONTGOMERY, PREBLE & WARREN (Wayne, Clear Creek & Franklin Townships)

	Rates	Fringes
ELECTRICIAN.....	\$ 32.15	20.51

ELEC0082-006 11/26/2018

CLINTON, DARKE, GREENE, MIAMI, MONTGOMERY, PREBLE & WARREN (Wayne, Clear Creek & Franklin Townships)

	Rates	Fringes
Sound & Communication Technician		
Cable Puller.....	\$ 12.18	3.85
Installer/Technician.....	\$ 24.35	11.29

ELEC0129-003 02/24/2020

LORAIN (Except Columbia Township) & MEDINA (Litchfield & Liverpool Townships)

	Rates	Fringes
ELECTRICIAN.....	\$ 35.35	17.68

ELEC0129-004 02/24/2020

ERIE & HURON (Lyme, Ridgefield, Norwalk, Townsend, Wakeman, Sherman, Peru, Bronson, Hartland, Clarksfield, Norwich, Greenfield, Fairfield, Fitchville & New London Townships)

	Rates	Fringes
ELECTRICIAN.....	\$ 35.35	17.68

ELEC0141-003 09/01/2019

BELMONT COUNTY

	Rates	Fringes
CABLE SPLICER.....	\$ 30.63	25.87
ELECTRICIAN.....	\$ 30.38	25.87

 ELEC0212-003 11/26/2018

BROWN, CLERMONT & HAMILTON

	Rates	Fringes
Sound & Communication Technician.....	\$ 24.35	10.99

 ELEC0212-005 06/03/2020

BROWN, CLERMONT, and HAMILTON COUNTIES

	Rates	Fringes
ELECTRICIAN.....	\$ 31.30	19.07

 ELEC0245-001 01/01/2020

ALLEN, HARDIN, VAN WERT & WYANDOT (Crawford, Jackson,
 Marseilles, Mifflin, Richland, Ridge & Salem Townships)

	Rates	Fringes
Line Construction		
Equipment Operator.....	\$ 32.37	25.9%+6.75
Groundman Truck Driver.....	\$ 17.70	25.9%+6.75
Lineman.....	\$ 40.46	25.9%+6.75

FOOTNOTE: a. Half day's Paid Holiday: The last 4 hours of
 the workday prior to Christmas or New Year's Day

 ELEC0245-003 01/01/2020

DEFIANCE, FULTON, HANCOCK, HENRY, HURON, LUCAS, OTTAWA,
 PAULDING, PUTNAM, SANDUSKY, SENECA, WILLIAMS, and WOOD COUNTIES

	Rates	Fringes
Line Construction		
Cable Splicer.....	\$ 46.53	25.9%+6.75
Groundman/Truck Driver.....	\$ 17.70	25.9%+6.75
Heli-arc Welding.....	\$ 40.76	25.9%+6.75
Lineman.....	\$ 40.46	25.9%+6.75
Operator - Class 1.....	\$ 32.37	25.9%+6.75
Operator - Class 2.....	\$ 28.32	25.9%+6.75
Traffic Signal & Lighting Technician.....	\$ 36.41	25.9%+6.75

FOOTNOTE: a. 6 Observed Holidays: New Year's Day; Memorial
 Day; Independence Day; Labor Day; Thanksgiving Day; &
 Christmas Day. Employees who work on a holiday shall be
 paid at a rate of double their applicable classified

straight-time rates for the work performed on such holiday.

ELEC0245-004 01/01/2020

ERIE COUNTY

	Rates	Fringes
Line Construction		
Cable Splicer.....	\$ 46.53	25.9%+6.75
Groundman/Truck Driver.....	\$ 17.70	25.9%+6.75
Lineman.....	\$ 40.46	25.9%+6.75
Operator - Class 1.....	\$ 32.37	25.9%+6.75
Operator - Class 2.....	\$ 28.32	25.9%+6.75

FOOTNOTE: a. 6 Observed Holidays: New Year's Day; Memorial Day; Independence Day; Labor Day; Thanksgiving Day; & Christmas Day. Employees who work on a holiday shall be paid at a rate of double their applicable classified straight-time rates for the work performed on such holiday.

ELEC0246-001 10/29/2018

	Rates	Fringes
ELECTRICIAN.....	\$ 38.00	84%+a

FOOTNOTE: a. 1 1/2 Paid Holidays: The last scheduled workday prior to Christmas & 4 hours on Good Friday.

ELEC0306-005 05/28/2018

MEDINA (Brunswick, Chatham, Granger, Guilford, Harrisville, Hinckley, Homer, Lafayette, Medina, Montville, Sharon, Spencer, Wadsworth, Westfield & York Townships), PORTAGE (Atwater, Aurora, Brimfield, Deerfield, Franklin, Mantua, Randolph, Ravenna, Rootstown, Shalersville, Streetsboro & Suffield Townships), SUMMIT & WAYNE (Baughman, Canaan, Chester, Chippewa, Congress, Green, Milton, & Wayne Townships)

	Rates	Fringes
CABLE SPLICER.....	\$ 36.87	16.56
ELECTRICIAN.....	\$ 34.54	5%+18.06

ELEC0317-002 06/01/2020

GALLIA & LAWRENCE

	Rates	Fringes
CABLE SPLICER.....	\$ 32.68	18.13
ELECTRICIAN.....	\$ 35.10	26.22

ELEC0540-005 12/28/2020

CARROLL (Northern half, including Fox, Harrison, Rose & Washington Townships), COLUMBIANA (Knox Township), HOLMES,

MAHONING (Smith Township), STARK, TUSCARAWAS (North of Auburn, Clay, Rush & York Townships), and WAYNE (South of Baughman, Chester, Green & Wayne Townships) COUNTIES

	Rates	Fringes
ELECTRICIAN.....	\$ 34.00	25.50

 ELEC0573-003 06/01/2020

ASHTABULA (Colebrook, Wayne, Williamsfield, Orwell & Windsor Townships), GEAUGA (Auburn, Middlefield, Parkman & Troy Townships), MAHONING (Milton Township), PORTAGE (Charlestown, Edinburg, Freedom, Hiram, Nelson, Palmyra, Paris & Windham Townships), and TRUMBULL (Except Liberty & Hubbard Townships)

	Rates	Fringes
ELECTRICIAN.....	\$ 34.11	19.46

 ELEC0575-001 11/30/2020

ADAMS, FAYETTE, HIGHLAND, HOCKING, JACKSON (Bloomfield, Franklin, Hamilton, Jefferson, Lick, Madison, Scioto, Coal, Jackson, Liberty, Milton & Washington Townships), PICKAWAY (Deer Creek, Perry, Pickaway, Salt Creek & Wayne Townships), PIKE (Beaver, Benton, Jackson, Mifflin, Pebble, PeePee, Perry, Seal, Camp Creek, Newton, Scioto, Sunfish, Union & Marion Townships), ROSS, SCIOTO & VINTON (Clinton, Eagle, Elk, Harrison, Jackson, Richland & Swan Townships)

	Rates	Fringes
ELECTRICIAN.....	\$ 33.75	19.22

 ELEC0648-001 09/02/2019

BUTLER and WARREN COUNTIES (Deerfield, Hamilton, Harlan, Massie, Salem, Turtle Creek, Union & Washington Townships)

	Rates	Fringes
CABLE SPLICER.....	\$ 30.50	18.23
ELECTRICIAN.....	\$ 30.00	19.85

 ELEC0673-004 02/01/2020

ASHTABULA (Excluding Orwell, Colebrook, Williamsfield, Wayne & Windsor Townships), GEAUGA (Burton, Chardon, Claridon, Hambden, Huntsburg, Montville, Munson, Newbury & Thompson Townships) and LAKE COUNTIES

	Rates	Fringes
CABLE SPLICER.....	\$ 33.81	21.47
ELECTRICIAN.....	\$ 33.56	21.47

ELEC0683-002 06/01/2020

CHAMPAIGN, CLARK, DELAWARE, FAIRFIELD, FRANKLIN, MADISON, PICKAWAY (Circleville, Darby, Harrison, Jackson, Madison, Monroe, Muhlenberg, Scioto, Walnut & Washington Townships), and UNION COUNTIES

	Rates	Fringes
CABLE SPLICER.....	\$ 35.50	21.06
ELECTRICIAN.....	\$ 34.50	21.06

ELEC0688-003 06/01/2020

ASHLAND, CRAWFORD, HURON (Richmond, New Haven, Ripley & Greenwich Townships), KNOX (Liberty, Clinton, Union, Howard, Monroe, Middleberry, Morris, Wayne, Berlin, Pike, Brown & Jefferson Townships), MARION, MORROW, RICHLAND and WYANDOT (Sycamore, Crane, Eden, Pitt, Antrim & Tymochtee Townships) COUNTIES

	Rates	Fringes
ELECTRICIAN.....	\$ 30.00	19.66

ELEC0972-002 06/01/2020

ATHENS, MEIGS, MONROE, MORGAN, NOBLE, VINTON (Brown, Knox, Madison, Vinton & Wilkesville Townships), and WASHINGTON COUNTIES

	Rates	Fringes
CABLE SPLICER.....	\$ 37.35	27.81
ELECTRICIAN.....	\$ 33.95	27.71

ELEC1105-001 05/28/2018

COSHOCTON, GUERNSEY, KNOX (Jackson, Clay, Morgan, Miller, Milford, Hilliar, Butler, Harrison, Pleasant & College Townships), LICKING, MUSKINGUM, PERRY, and TUSCARAWAS (Auburn, York, Clay, Jefferson, Rush, Oxford, Washington, Salem, Perry & Bucks Townships) COUNTIES

	Rates	Fringes
ELECTRICIAN.....	\$ 30.95	17.96

ENGI0018-003 05/01/2019

ASHTABULA, CUYAHOGA, ERIE, GEAUGA, LAKE, LORAIN, MEDINA, PORTAGE, and SUMMIT COUNTIES

	Rates	Fringes
POWER EQUIPMENT OPERATOR GROUP 1.....	\$ 38.63	15.20

GROUP 2.....	\$ 38.53	15.20
GROUP 3.....	\$ 37.49	15.20
GROUP 4.....	\$ 36.27	15.20
GROUP 5.....	\$ 30.98	15.20
GROUP 6.....	\$ 38.88	15.20
GROUP 7.....	\$ 39.13	15.20

OPERATING ENGINEER CLASSIFICATIONS

GROUP 1 - Air Compressor on Steel Erection; Barrier Moving Machine; Boiler Operator on Compressor or Generator when mounted on a Rig; Cableway; Combination Concrete Mixer & Tower; Concrete Plant (over 4 yd. Capacity); Concrete Pump; Crane (All Types, Including Boom Truck, Cherry Picker); Crane-Compact, Track or Rubber over 4,000 lbs. capacity; Cranes-Self Erecting, Stationary, Track or Truck (All Configurations); Derrick; Dragline; Dredge (Dipper, Clam or Suction); Elevating Grader or Euclid Loader; Floating Equipment (All Types); Gradall; Helicopter Crew (Operator-Hoist or Winch); Hoe (all types); Hoisting Engine on Shaft or Tunnel Work; Hydraulic Gantry (Lifting System); Industrial-Type Tractor; Jet Engine Dryer (D8 or D9) Diesel Tractor; Locomotive (Standard Gauge); Maintenance Operator Class A; Mixer, Paving (Single or Double Drum); Mucking Machine; Multiple Scraper; Piledriving Machine (All Types); Power Shovel; Prentice Loader; Quad 9 (Double Pusher); Rail Tamper (with auto lifting & aligning device); Refrigerating Machine (Freezer Operation); Rotary Drill, on Caisson work; Rough Terrain Fork Lift with Winch/Hoist; Side-Boom; Slip-Form Paver; Tower Derrick; Tree Shredder; Trench Machine (Over 24" wide); Truck Mounted Concrete Pump; Tug Boat; Tunnel Machine and/or Mining Machine; Wheel Excavator; and Asphalt Plant Engineer (Cleveland District Only).

GROUP 2 - Asphalt Paver; Automatic Subgrader Machine, Self-Propelled (CMI Type); Bobcat Type and/or Skid Steer Loader with Hoe Attachment Greater than 7,000 lbs.; Boring Machine More than 48"; Bulldozer; Endloader; Horizontal Directional Drill (Over 50,000 ft lbs thrust); Hydro Milling Machine; Kolman-type Loader (production type-Dirt); Lead Greaseman; Lighting & Traffic Signal Installation Equipment (includes all groups or classifications); Material Transfer Equipment (Shuttle Buggy) Asphalt; Pettibone-Rail Equipment; Power Grader; Power Scraper; Push Cat; Rotomill (all), Grinders & Planers of All types; Trench Machine (24" wide & under); Vermeer type Concrete Saw; and Maintenance Operators (Portage and Summit Counties Only).

GROUP 3 - A-Frame; Air Compressor on Tunnel Work (low pressure); Asphalt Plant Engineer (Portage and Summit Counties Only); Bobcat-type and/or Skid Steer Loader with or without Attachments; Highway Drills (all types); Locomotive (narrow gauge); Material Hoist/Elevator; Mixer, Concrete (more than one bag capacity); Mixer, one bag capacity (Side Loader); Power Boiler (Over 15 lbs. Pressure) Pump Operator installing & operating Well Points; Pump (4" & over discharge); Roller, Asphalt; Rotovator (lime soil stabilizer); Switch & Tie Tampers (without lifting & aligning device); Utility Operator (Small equipment); Welding Machines; and Railroad Tie

Inserter/Remove; Articulating/straight bed end dumps if assigned (minus \$4.00 per hour.

GROUP 4 - Backfiller; Ballast Re-locator; Bars, Joint & Mesh Installing Machine; Batch Plant; Boring Machine Operator (48" or less); Bull Floats; Burlap & Curing Machine; Concrete Plant (capacity 4 yd. & under); Concrete Saw (Multiple); Conveyor (Highway); Crusher; Deckhand; Farm-type Tractor with attachments (highway); Finishing Machine; Fireperson, Floating Equipment (all types); Forklift; Form Trencher; Hydro Hammer expect masonry; Hydro Seeder; Pavement Breaker; Plant Mixer; Post Driver; Post Hole Digger (Power Auger); Power Brush Burner; Power Form Handling Equipment; Road Widening Trencher; Roller (Brick, Grade & Macadam); Self-Propelled Power Spreader; Self-Propelled Power Subgrader; Steam Fireperson; Tractor (Pulling Sheepfoot, Roller or Grader); and Vibratory Compactor with Integral Power.

GROUP 5 - Compressor (Portable, Sewer, Heavy & Highway); Drum Fireperson (Asphalt Plant); Generator; Masonry Fork Lift; Inboard-Outboard Motor Boat Launch; Oil Heater (asphalt plant); Oiler/Helper; Power Driven Heater; Power Sweeper & Scrubber; Pump (under 4" discharge); Signalperson; Tire Repairperson; VAC/ALLS; Cranes - Compact, track or rubber under 4,000 pound capacity; fueling and greasing; and Chainmen.

GROUP 6 - Master Mechanic & Boom from 150 to 180.

GROUP 7 - Boom from 180 and over.

ENGI0018-004 05/01/2019

ADAMS, ALLEN, ASHLAND, ATHENS, AUGLAIZE, BELMONT, BROWN, BUTLER, CARROLL, CHAMPAIGN, CLARK, CLERMONT, CLINTON, COSHOCTON, CRAWFORD, DARKE, DEFIANCE, DELAWARE, FAIRFIELD, FAYETTE, FRANKLIN, FULTON, GALLIA, GREENE, GUERNSEY, HAMILTON, HANCOCK, HARDIN, HARRISON, HENRY, HIGHLAND, HOCKING, HOLMES, HURON, JACKSON, JEFFERSON, KNOX, LAWRENCE, LICKING, LOGAN, LUCAS, MADISON, MARION, MEIGS, MERCER, MIAMI, MONROE, MONTGOMERY, MORGAN, MORROW, MUSKINGUM, NOBLE, OTTAWA, PAULDING, PERRY, PICKAWAY, PIKE, PREBLE, PUTNAM, RICHLAND, ROSS, SANDUSKY, SCIOTO, SENECA, SHELBY, STARK, TUSCARAWAS, UNION, VAN WERT, VINTON, WARREN, WASHINGTON, WAYNE, WILLIAMS, WOOD, and YANDOT COUNTIES

	Rates	Fringes
POWER EQUIPMENT OPERATOR		
GROUP 1.....	\$ 37.14	15.20
GROUP 2.....	\$ 37.02	15.20
GROUP 3.....	\$ 35.98	15.20
GROUP 4.....	\$ 34.80	15.20
GROUP 5.....	\$ 29.34	15.20
GROUP 6.....	\$ 37.39	15.20
GROUP 7.....	\$ 37.64	15.20

OPERATING ENGINEER CLASSIFICATIONS

GROUP 1 - Air Compressor on Steel Erection; Barrier Moving Machine; Boiler Operator on Compressor or Generator when mounted on a Rig; Cableway; Combination Concrete Mixer & Tower; Concrete Plant (over 4 yd. Capacity); Concrete Pump; Crane (All Types, Including Boom Truck, Cherry Picker); Crane-Compact, Track or Rubber over 4,000 lbs. capacity; Cranes-Self Erecting, Stationary, Track or Truck (All Configurations); Derrick; Dragline; Dredge (Dipper, Clam or Suction); Elevating Grader or Euclid Loader; Floating Equipment (All Types); Gradall; Helicopter Crew (Operator-Hoist or Winch); Hoe (all types); Hoisting Engine on Shaft or Tunnel Work; Hydraulic Gantry (Lifting System); Industrial-Type Tractor; Jet Engine Dryer (D8 or D9) Diesel Tractor; Locomotive (Standard Gauge); Maintenance Operator Class A; Mixer, Paving (Single or Double Drum); Mucking Machine; Multiple Scraper; Piledriving Machine (All Types); Power Shovel; Prentice Loader; Quad 9 (Double Pusher); Rail Tamper (with auto lifting & aligning device); Refrigerating Machine (Freezer Operation); Rotary Drill, on Caisson work; Rough Terrain Fork Lift with Winch/Hoist; Side-Boom; Slip-Form Paver; Tower Derrick; Tree Shredder; Trench Machine (Over 24" wide); Truck Mounted Concrete Pump; Tug Boat; Tunnel Machine and/or Mining Machine; and Wheel Excavator.

GROUP 2 - Asphalt Paver; Automatic Subgrader Machine, Self-Propelled (CMI Type); Bobcat Type and/or Skid Steer Loader with Hoe Attachment Greater than 7,000 lbs.; Boring Machine More than 48"; Bulldozer; Endloader; Hydro Milling Machine; Horizontal Directional Drill (over 50,000 ft. lbs. thrust); Kolman-type Loader (production type-Dirt); Lead Greaseman; Lighting & Traffic Signal Installation Equipment (includes all groups or classifications); Material Transfer Equipment (Shuttle Buggy) Asphalt; Pettibone-Rail Equipment; Power Grader; Power Scraper; Push Cat; Rotomill (all), Grinders & Planers of All types; Trench Machine (24" wide & under); and Vermeer type Concrete Saw.

GROUP 3 - A-Frame; Air Compressor on Tunnel Work (low pressure); Asphalt Plant Engineer; Bobcat-type and/or Skid Steer Loader with or without Attachments; Highway Drills (all types); Locomotive (narrow gauge); Material Hoist/Elevator; Mixer, Concrete (more than one bag capacity); Mixer, one bag capacity (Side Loader); Power Boiler (Over 15 lbs. Pressure) Pump Operator installing & operating Well Points; Pump (4" & over discharge); Railroad Tie Inserter/Remover; Roller, Asphalt; Rotovator (lime soil stabilizer); Switch & Tie Tampers (without lifting & aligning device); Utility Operator (Small equipment); and Welding Machines; Articulating/straight bed end dumps if assigned (minus \$4.00 per hour).

GROUP 4 - Backfiller; Ballast Re-locator; Bars, Joint & Mesh Installing Machine; Batch Plant; Boring Machine Operator (48" or less); Bull Floats; Burlap & Curing Machine; Concrete Plant (capacity 4 yd. & under); Concrete Saw (Multiple); Conveyor (Highway); Crusher; Deckhand; Farm-type Tractor with attachments (highway); Finishing Machine; Fireperson, Floating Equipment (all types); Fork Lift; Form Trencher; Hydro Hammer expect masonry; Hydro Seeder; Pavement Breaker; Plant Mixer; Post Driver; Post Hole Digger (Power Auger); Power Brush Burner; Power Form

Handling Equipment; Road Widening Trencher; Roller (Brick, Grade & Macadam); Self-Propelled Power Spreader; Self-Propelled Power Subgrader; Steam Fireperson; Tractor (Pulling Sheepfoot, Roller or Grader); and Vibratory Compactor with Integral Power.

GROUP 5 - Compressor (Portable, Sewer, Heavy & Highway); Drum Fireperson (Asphalt Plant); Generator; Masonary Forklift; Inboard-Outboard Motor Boat Launch; Oil Heater (asphalt plant); Oiler/Helper; Power Driven Heater; Power Sweeper & Scrubber; Pump (under 4" discharge); Signalperson; Tire Repairperson; VAC/ALLS; Cranes - Compact, track or rubber under 4,000 pound capacity; fueling and greasing; and Chainmen.

GROUP 6 - Master Mechanic & Boom from 150 to 180.

GROUP 7 - Boom from 180 and over.

 ENGI0066-023 06/01/2017

COLUMBIANA, MAHONING & TRUMBULL COUNTIES

	Rates	Fringes
POWER EQUIPMENT OPERATOR		
ASBESTOS; HAZARDOUS/TOXIC WASTE PROJECTS		
GROUP 1 - A & B.....	\$ 39.23	19.66
ASBESTOS; HAZARDOUS/TOXIC WASTE PROJECTS		
GROUP 2 - A & B.....	\$ 38.90	19.66
ASBESTOS; HAZARDOUS/TOXIC WASTE PROJECTS		
GROUP 3 - A & B.....	\$ 34.64	19.66
ASBESTOS; HAZARDOUS/TOXIC WASTE PROJECTS		
GROUP 4 - A & B.....	\$ 30.70	19.66
ASBESTOS; HAZARDOUS/TOXIC WASTE PROJECTS		
GROUP 5 - A & B.....	\$ 27.30	19.66
HAZARDOUS/TOXIC WASTE PROJECTS		
GROUP 1 - C & D.....	\$ 35.96	19.66
HAZARDOUS/TOXIC WASTE PROJECTS		
GROUP 2 - C & D.....	\$ 35.66	19.66
HAZARDOUS/TOXIC WASTE PROJECTS		
GROUP 3 - C & D.....	\$ 31.76	19.66
HAZARDOUS/TOXIC WASTE PROJECTS		

GROUP 4 - C & D.....\$ 28.14	19.66
HAZARDOUS/TOXIC WASTE PROJECTS	
GROUP 5 - C & D.....\$ 25.03	19.66
ALL OTHER WORK	
GROUP 1.....\$ 32.69	19.66
ALL OTHER WORK	
GROUP 2.....\$ 32.42	19.66
ALL OTHER WORK	
GROUP 3.....\$ 28.87	19.66
ALL OTHER WORK	
GROUP 4.....\$ 25.58	19.66
ALL OTHER WORK	
GROUP 5.....\$ 22.75	19.66

GROUP 1 - Rig, Pile Driver or Caisson Type; & Rig, Pile Hydraulic Unit Attached

GROUP 2 - Asphalt Heater Planer; Backfiller with Drag Attachment; Backhoe; Backhoe with Shear attached; Backhoe-Rear Pivotal Swing; Batch Plant-Central Mix Concrete; Batch Plant, Portable concrete; Berm Builder-Automatic; Boat Derrick; Boat-Tug; Boring Machine Attached to Tractor; Bullclam; Bulldozer; C.M.I. Road Builder & Similar Type; Cable Placer & Layer; Carrier-Straddle; Carryall-Scraper or Scoop; Chicago Boom; Compactor with Blade Attached; Concrete Saw (Vermeer or similar type); Concrete Spreader Finisher; Combination, Bidwell Machine; Crane; Crane-Electric Overhead; Crane-Rough Terrain; Crane-Side Boom; Crane-Truck; Crane-Tower; Derrick-Boom; Derrick-Car; Digger-Wheel (Not trencher or road widener); Double Nine; Drag Line; Dredge; Drill-Kenny or Similar Type; Easy Pour Median Barrier Machine (or similar type); Electromatic; Frankie Pile; Gradall; Grader; Gurry; Self-Propelled; Heavy Equipment Robotics Operator/Mechanic; Hoist-Monorail; Hoist-Stationary & Mobile Tractor; Hoist, 2 or 3 drum; Horizontal Directional Drill Operator; Jackall; Jumbo Machine; Kocal & Kuhlman; Land-Seagoing Vehicle; Loader, Elevating; Loader, Front End; Loader, Skid Steer; Locomotive; Mechanic/Welder; Metro Chip Harvester with Boom; Mucking Machine; Paver-Asphalt Finishing Machine; Paver-Road Concrete; Paver-Slip Form (C.M.I. or similar); Place Crete Machine with Boom; Post Driver (Carrier mounted); Power Driven Hydraulic Pump & Jack (When used in Slip Form or Lift Slab Construction); Pump Crete Machine; Regulator-Ballast; Hydraulic Power Unit not attached to Rig for Pile Drillings; Rigs-Drilling; Roto Mill or similar Full Lane (8' Wide & Over); Roto Mill or similar type (Under 8'); Shovel; Slip Form Curb Machine; Speedwing; Spikemaster; Stonecrusher; Tie Puller & Loader; Tie Tamper; Tractor-Double Boom; Tractor with Attachments; Truck-Boom; Truck-Tire; Trench Machine; Tunnel Machine (Mark 21 Java or similar); & Whirley (or similar type)

GROUP 3 - Asphalt Plant; Bending Machine (Pipeline or similar

type); Boring machine, Motor Driven; Chip Harvester without Boom; Cleaning Machine, Pipeline Type; Coating Machine, Pipeline Type; Compactor; Concrete Belt Placer; Concrete Finisher; Concrete Planer or Asphalt; Concrete Spreader; Elevator; Fork Lift (Home building only); Fork lift & Lulls; Fork Lift Walk Behind (Hoisting over 1 buck high); Form Line Machine; Grease Truck operator; Grout Pump; Gunnite Machine; Horizontal Directional Drill Locator; Single Drum Hoist with or without Tower; Huck Bolting Machine; Hydraulic Scaffold (Hoisting building materials); Paving Breaker (Self-propelled or Ridden); Pipe Dream; Pot Fireperson (Power Agitated); Refrigeration Plant; Road Widener; Roller; Sasgen Derrick; Seeding Machine; Soil Stabilizer (Pump type); Spray Cure Machine, Self-Propelled; Straw Blower Machine; Sub-Grader; Tube Finisher or Broom C.M.I. or similar type; & Tugger Hoist

GROUP 4 - Air Curtain Destructor & Similar Type; Batch Plant-Job Related; Boiler Operator; Compressor; Conveyor; Curb Builder, self-propelled; Drill Wagon; Generator Set; Generator-Steam; Heater-Portable Power; Hydraulic Manipulator Crane; Jack-Hydraulic Power driven; Jack-Hydraulic (Railroad); Ladavator; Minor Machine Operator; Mixer-Concrete; Mulching Machine; Pin Puller; Power Broom; Pulverizer; Pump; Road Finishing Machine (Pull Type); Saw-Concrete-Self-Propelled (Highway Work); Signal Person; Spray Cure Machine-Motor Powered; Stump Cutter; Tractor; Trencher Form; Water Blaster; Steam Jenny; Syphon; Vibrator-Gasoline; & Welding Machine

GROUP 5 - Brakeperson; Fireperson; & Oiler

 IRON0017-002 05/01/2020

ASHTABULA (North of Route 6, starting at the Geauga County Line, proceeding east to State Route 45), CUYAHOGA, ERIE (Eastern 2/3), GEAUGA, HURON (East of a line drawn from the north border through Monroeville & Willard), LAKE, LORAIN, MEDINA (North of Old Rte. #224), PORTAGE (West of a line from Middlefield to Shalersville to Deerfield), and SUMMIT (North of Old Rte. #224, including city limits of Barberton) COUNTIES

Rates Fringes

IRONWORKER
 Ornamental, Reinforcing, &
 Structural.....\$ 35.93 23.11

 IRON0017-010 05/01/2020

ASHTABULA (Eastern part from Lake Erie on the north to route #322 on the south to include Conneaut, Kingsville, Sheffield, Denmark, Dorset, Cherry Valley, Wayne, Monroe, Pierpont, Richmond, Andover & Williamsfield Townships)

Rates Fringes

IRONWORKER
 Structural, including

Tunnels & Caissons Under

Pressure.....	\$ 29.77	21.30
All Other Work.....	\$ 30.38	24.40

IRON0147-002 06/01/2020

ALLEN (Northern half), DEFIANCE (Northern part, excluding south of a line drawn from where Rte. #66 meets the northern line through Independence to the eastern county border), MERCER (Northern half), PAULDING, PUTNAM (Western part, excluding east of a line drawn from the northern border down through Miller City to where #696 meets the southern border), VAN WERT, and WILLIAMS (Western part, excluding east of a line drawn from Pioneer through Stryker to the southern border) COUNTIES

	Rates	Fringes
IRONWORKER.....	\$ 29.58	23.27

IRON0172-002 06/01/2020

CHAMPAIGN (Eastern one-third), CLARK (Eastern one-fourth), COSHOCTON (West of a line beginning at the northwestern county line going through Walhonding & Tunnel Hill to the southern county line), CRAWFORD (South of Rte. #30), DELAWARE, FAIRFIELD, FAYETTE, FRANKLIN, HARDIN (Excluding a line drawn from Roundhead to Maysville), HIGHLAND (Eastern one-fifth), HOCKING, JACKSON (Northern half), KNOX, LICKING, LOGAN (Eastern one-third), MADISON, MARION, MORROW, MUSKINGUM (West of a line starting at Adams Mill going to Adamsville & going from Adamsville through Blue Rock to the southern border), PERRY, PICKAWAY, PIKE (Northern half), ROSS, UNION, VINTON and WYANDOT (South of Rte. #30) COUNTIES

	Rates	Fringes
IRONWORKER.....	\$ 30.75	20.80

IRON0207-004 06/01/2020

ASHTABULA (Southern part starting at the Geauga County line), COLUMBIANA (E. of a line from Damascus to Highlandtown), MAHONING (N. of Old Route #224), PORTAGE (E. of a line from Middlefield to Shalersville to Deerfield) & TRUMBULL

	Rates	Fringes
IRONWORKER		
Layout; Sheeter.....	\$ 31.25	25.75
Ornamental; Reinforcing;		
Structural.....	\$ 28.06	24.70
Ornamental; Reinforcing.....	\$ 30.25	25.75

IRON0290-002 06/01/2020

ALLEN (Southern half), AUGLAIZE, BUTLER (North of a line drawn from east to the west county line going through Oxford, Darrtown & Woodsdale), CHAMPAIGN (Excluding east of a line drawn from Catawla to the point where #68 intersects the

northern county line), CLARK (Western two-thirds), CLINTON (Excluding south of a line drawn from Blanchester to Lynchburg), DARKE, GREENE, HIGHLAND (Inside lines drawn from Marshall to Lynchburg & from the northern county line through East Monroe to Marshall), LOGAN (West of a line drawn from West Liberty to where the northern county line meets the western county line of Hardin), MERCER (Southern half), MIAMI, MONTGOMERY, PREBLE, SHELBY & WARREN (Excluding south of a line drawn from Blanchester through Morrow to the western county line) COUNTIES

	Rates	Fringes
IRONWORKER.....	\$ 29.68	22.90

IRON0549-003 12/01/2020

BELMONT, GUERNSEY, HARRISON, JEFFERSON, MONROE & MUSKINGUM (Excluding portion west of a line starting at Adams Mill going to Adamsville and going from Adamsville through Blue Rock to the south border)

	Rates	Fringes
IRONWORKER.....	\$ 34.03	23.22

IRON0550-004 05/01/2020

ASHLAND, CARROLL, COLUMBIANA (W. of a line from Damascus to Highlandtown), COSHOCTON (E. of a line beginning at NW Co. line going through Walhonding & Tunnel Hill to the South Co. line), HOLMES, HURON (S. of Old Rte. #224), MAHONING (S. of Old Rte. #224), MEDINA (S. of Old Rte. #224), PORTAGE (S. of Old Rte. #224), RICHLAND, STARK, SUMMIT (S. of Old Rte. #224, Excluding city limits of Barberton), TUSCARAWAS, & WAYNE

	Rates	Fringes
Ironworkers:Structural, Ornamental and Reinforcing.....	\$ 29.27	20.87

IRON0769-004 06/01/2020

ADAMS (Eastern Half), GALLIA, JACKSON (Southern Half), LAWRENCE & SCIOTO

	Rates	Fringes
IRONWORKER.....	\$ 32.75	26.34

IRON0787-003 12/01/2020

ATHENS, MEIGS, MORGAN, NOBLE, and WASHINGTON COUNTIES

	Rates	Fringes
IRONWORKER.....	\$ 30.98	22.75

	Rates	Fringes
LABORER		
ASHTABULA, ERIE, HURON, LORAIN, LUCAS, MAHONING, MEDINA, OTTAWA, PORTAGE, SANDUSKY, STARK, SUMMIT, TRUMBULL & WOOD COUNTIES		
GROUP 1.....	\$ 33.05	11.25
GROUP 2.....	\$ 33.22	11.25
GROUP 3.....	\$ 33.55	11.25
GROUP 4.....	\$ 34.00	11.25
CUYAHOGA AND GEAUGA COUNTIES ONLY: SEWAGE PLANTS, WASTE PLANTS, WATER TREATMENT FACILITIES, PUMPING STATIONS, & ETHANOL PLANTS CONSTRUCTION.....		
	\$ 35.66	11.25
CUYAHOGA, GEAUGA & LAKE COUNTIES		
GROUP 1.....	\$ 34.28	11.25
GROUP 2.....	\$ 34.45	11.25
GROUP 3.....	\$ 34.78	11.25
GROUP 4.....	\$ 35.23	11.25
REMAINING COUNTIES OF OHIO		
GROUP 1.....	\$ 32.62	11.25
GROUP 2.....	\$ 32.79	11.25
GROUP 3.....	\$ 33.12	11.25
GROUP 4.....	\$ 33.57	11.25

LABORER CLASSIFICATIONS

GROUP 1 - Asphalt Laborer; Carpenter Tender; Concrete Curing Applicator; Dump Man (Batch Truck); Guardrail and Fence Installer; Joint Setter; Laborer (Construction); Landscape Laborer; Mesh Handlers & Placer; Right-of-way Laborer; Riprap Laborer & Grouter; Scaffold Erector; Seal Coating; Surface Treatment or Road Mix Laborer; Sign Installer; Slurry Seal; Utility Man; Bridge Man; Handyman; Waterproofing Laborer; Flagperson; Hazardous Waste (level D); Diver Tender; Zone Person & Traffic Control

GROUP 2 - Asphalt Raker; Concrete Puddler; Kettle Man Pipeline); Machine Driven Tools (Gas, Electric, Air); Mason Tender; Brick Paver; Mortar Mixer; Power Buggy or Power Wheelbarrow; Paint Striper; Sheeting & Shoring Man; Surface Grinder Man; Plastic Fusing Machine Operator; Pug Mill Operator; & Vacuum Devices (wet or dry); Rodding Machine Operator; Diver; Screwman or Paver; Screed Person; Water Blast, Hand Held Wand; Pumps 4" & Under (Gas, Air or Electric) & Hazardous Waste (level C); Air Track and Wagon Drill; Bottom Person; Cofferdam (below 25 ft. deep); Concrete Saw Person; Cutting with Burning Torch; Form Setter; Hand Spiker (Railroad); Pipelayer; Tunnel Laborer (without air) & Caisson; Underground Person (working in Sewer and Waterline, Cleaning, Repairing & Reconditioning); Sandblaster Nozzle Person; & Hazardous Waste (level B)

GROUP 3 - Blaster; Mucker; Powder Person; Top Lander;

Wrencher (Mechanical Joints & Utility Pipeline); Yarner; Hazardous Waste (level A); Concrete Specialist; Concrete Crew in Tunnels (With Air-pressurized - \$1.00 premium); Curb Setter & Cutter; Grade Checker; Utility Pipeline Tapper; Waterline; and Caulker

GROUP 4 - Miner (With Air-pressurized - \$1.00 premium); & Gunite Nozzle Person

TUNNEL LABORER WITH AIR-PRESSURIZED ADD \$1.00 TO BASE RATE

SIGNAL PERSON WILL RECEIVE THE RATE EQUAL TO THE RATE PAID THE LABORER CLASSIFICATION FOR WHICH HE OR SHE IS SIGNALING.

PAIN0006-002 05/01/2018

ASHTABULA, CUYAHOGA, GEAUGA, LAKE, LORAIN, PORTAGE (N. of the East-West Turnpike) & SUMMIT (N. of the East-West Turnpike)

	Rates	Fringes
PAINTER		
COMMERCIAL NEW WORK; REMODELING; & RENOVATIONS		
GROUP 1.....	\$ 27.90	16.16
GROUP 2.....	\$ 28.30	16.16
GROUP 3.....	\$ 28.60	16.16
GROUP 4.....	\$ 34.16	16.16
COMMERCIAL REPAINT		
GROUP 1.....	\$ 26.40	16.16
GROUP 2.....	\$ 26.80	16.16
GROUP 3.....	\$ 27.10	16.16

PAINTER CLASSIFICATIONS - COMMERCIAL NEW WORK; REMODELING; & RENOVATIONS

GROUP 1 - Brush; & Roller

GROUP 2 - Sandblasting & Buffing

GROUP 3 - Spray Painting; Closed Steel Above 55 feet; Bridges & Open Structural Steel; Tanks - Water Towers; Bridge Painters; Bridge Riggers; Containment Builders

GROUP 4 - Bridge Blaster

PAINTER CLASSIFICATIONS - COMMERCIAL REPAINT

GROUP 1 - Brush; & Roller

GROUP 2 - Sandblasting & Buffing

GROUP 3 - Spray Painting

PAIN0007-002 07/01/2019

FULTON, HENRY, LUCAS, OTTAWA (Excluding Allen, Bay, Bono, Catawba Island, Clay Center, Curtice, Danbury, Eagle Beach, Elliston, Elmore, Erie, Fishback, Gem Beach & Genova) & WOOD

	Rates	Fringes
PAINTER		
NEW COMMERCIAL WORK		
GROUP 1.....	\$ 27.64	17.79
GROUP 2.....	\$ 27.39	17.79
GROUP 3.....	\$ 27.39	17.79
GROUP 4.....	\$ 27.39	17.79
GROUP 5.....	\$ 27.39	17.79
GROUP 6.....	\$ 27.39	17.79
GROUP 7.....	\$ 27.39	17.79
GROUP 8.....	\$ 27.39	17.79
GROUP 9.....	\$ 27.39	17.79

REPAINT IS 90% OF JR

PAINTER CLASSIFICATIONS

GROUP 1 - Brush; Spray & Sandblasting Pot Tender

GROUP 2 - Refineries & Refinery Tanks; Surfaces 30 ft. or over where material is applied to or labor performed on above ground level (exterior), floor level (interior)

GROUP 3 - Swing Stage & Chair

GROUP 4 - Lead Abatement

GROUP 5 - All Methods of Spray

GROUP 6 - Solvent-Based Catalized Epoxy Materials of 2 or More Component Materials, to include Solvent-Based Conversion Varnish (excluding water based)

GROUP 7 - Spray Solvent Based Material; Sand & Abrasive Blasting

GROUP 8 - Towers; Tanks; Bridges; Stacks Over 30 Feet

GROUP 9 - Epoxy Spray (excluding water based)

PAIN0012-008 05/01/2019

BUTLER COUNTY

	Rates	Fringes
PAINTER		
GROUP 1.....	\$ 21.95	10.20
GROUP 2.....	\$ 25.30	10.20
GROUP 3.....	\$ 25.80	10.20
GROUP 4.....	\$ 26.05	10.20
GROUP 5.....	\$ 26.30	10.20

PAINTER CLASSIFICATIONS

GROUP 1: Bridge Equipment Tender; Bridge/Containment Builder

GROUP 2: Brush & Roller

GROUP 3: Spray

GROUP 4: Sandblasting; & Waterblasting

GROUP 5: Elevated Tanks; Steeplejack Work; Bridge; & Lead Abatement

PAIN0012-010 05/01/2019

BROWN, CLERMONT, CLINTON, HAMILTON & WARREN

	Rates	Fringes
PAINTER		
HEAVY & HIGHWAY BRIDGES-		
GUARDRAILS-LIGHTPOLES-		
STRIPING		
Bridge Equipment Tender and Containment Builder....	\$ 21.95	10.20
Bridges when highest point of clearance is 60 feet or more; & Lead Abatement Projects.....	\$ 26.30	10.20
Brush & Roller.....	\$ 25.30	10.20
Sandblasting & Hopper Tender; Water Blasting.....	\$ 26.05	10.20
Spray.....	\$ 25.80	10.20

PAIN0093-001 12/01/2018

ATHENS, GUERNSEY, HOCKING, MONROE, MORGAN, NOBLE and WASHINGTON COUNTIES

	Rates	Fringes
PAINTER		
Bridges; Locks; Dams; Tension Towers; & Energized Substations.....		
	\$ 34.04	18.50
Power Generating Facilities.	\$ 30.89	18.50

PAIN0249-002 06/01/2020

CLARK, DARKE, GREENE, MIAMI, MONTGOMERY & PREBLE

	Rates	Fringes
PAINTER		
GROUP 1 - Brush & Roller....	\$ 24.17	11.22
GROUP 2 - Swing, Scaffold Bridges; Structural Steel; Open Acid Tank; High Tension Electrical Equipment; & Hot Pipes.....	\$ 24.17	11.22
GROUP 3 - Spray; Sandblast; Steamclean;		

Lead Abatement.....	\$ 24.92	11.22
GROUP 4 - Steeplejack Work..	\$ 25.12	11.22
GROUP 5 - Coal Tar.....	\$ 25.67	11.22
GROUP 6 - Bridge Equipment Tender & or Containment Builder.....	\$ 32.88	11.22
GROUP 7 - Tanks, Stacks & Towers.....	\$ 27.81	11.22
GROUP 8 - Bridge Blaster, Rigger.....	\$ 35.88	11.22

PAIN0356-002 09/01/2009

KNOX, LICKING, MUSKINGUM, and PERRY

	Rates	Fringes
PAINTER		
Bridge Equipment Tenders and Containment Builders....	\$ 27.93	7.25
Bridges; Blasters; and Riggers.....	\$ 34.60	7.25
Brush and Roller.....	\$ 20.93	7.25
Sandblasting; Steam Cleaning; Waterblasting; and Hazardous Work.....	\$ 25.82	7.25
Spray.....	\$ 21.40	7.25
Structural Steel and Swing Stage.....	\$ 25.42	7.25
Tanks; Stacks; and Towers...\$	28.63	7.25

PAIN0438-002 12/01/2018

BELMONT, HARRISON and JEFFERSON COUNTIES

	Rates	Fringes
PAINTER		
Bridges, Locks, Dams, Tension Towers & Energized Substations.....	\$ 32.80	17.68
Power Generating Facilities.\$	29.65	17.68

PAIN0476-001 06/01/2020

COLUMBIANA, MAHONING, and TRUMBULL COUNTIES

	Rates	Fringes
PAINTER		
GROUP 1.....	\$ 26.47	14.53
GROUP 2.....	\$ 33.10	14.53
GROUP 3.....	\$ 26.68	14.53
GROUP 4.....	\$ 27.12	14.53
GROUP 5.....	\$ 27.12	14.53
GROUP 6.....	\$ 27.37	14.53
GROUP 7.....	\$ 28.47	14.53

PAINTER CLASSIFICATIONS:

GROUP 1: Painters, Brush & Roller

GROUP 2: Bridges

GROUP 3: Structural Steel

GROUP 4: Spray, Except Bar Joist/Deck

GROUP 5: Epoxy/Mastic; Spray- Bar Joist/Deck; Working Above 50 Feet; and Swingstages

GROUP 6: Tanks; Sandblasting

GROUP 7: Towers; Stacks

PAIN0555-002 09/01/2020

ADAMS, HIGHLAND, JACKSON, PIKE & SCIOTO

	Rates	Fringes
PAINTER		
GROUP 1.....	\$ 31.48	16.46
GROUP 2.....	\$ 32.97	16.46
GROUP 3.....	\$ 34.46	16.46
GROUP 4.....	\$ 37.38	16.46

PAINTER CLASSIFICATIONS

GROUP 1 - Containment Builder

GROUP 2 - Brush; Roller; Power Tools, Under 40 feet

GROUP 3 - Sand Blasting; Spray; Steam Cleaning; Pressure Washing; Epoxy & Two Component Materials; Lead Abatement; Hazardous Waste; Toxic Materials; Bulk & Storage Tanks of 25,000 Gallon Capacity or More; Elevated Tanks

GROUP 4 - Stacks; Bridges

PAIN0639-001 05/01/2011

	Rates	Fringes
Sign Painter & Erector.....	\$ 20.61	3.50+a+b+c

FOOTNOTES: a. 7 Paid Holidays: New Year's Day; Memorial Day; July 4th; Labor Day; Thanksgiving Day; Christmas Day & 1 Floating Day

b. Vacation Pay: After 1 year's service - 5 days' paid vacation; After 2, but less than 10 years' service - 10 days' paid vacation; After 10, but less than 20 years' service - 15 days' paid vacation; After 20 years' service - 20 days' paid vacation

c. Funeral leave up to 3 days maximum paid leave for death of mother, father, brother, sister, spouse, child, mother-in-law, father-in-law, grandparent and inlaw provided employee attends funeral

PAIN0788-002 06/01/2020

ASHLAND, CRAWFORD, ERIE, HANCOCK, HURON, MARION, MORROW, OTTAWA
 (Allen, Bay, Bono, Catawba Island, Clay Center, Curtice,
 Danbury, Eagle Beach, Elliston, Elmore, Erie, Fishback, Gem
 Beach & Genoa), RICHLAND, SANDUSKY, SENECA & WYANDOT

	Rates	Fringes
PAINTER		
Brush & Roller.....	\$ 24.66	14.05
Structural Steel.....	\$ 26.26	14.05

WINTER REPAINT: Between December 1 to March 31 - 90%JR

\$.50 PER HOUR SHALL BE ADDED TO THE RATE OF PAY FOR THE
 CLASSIFICATION OF WORK:

While working swingstage, boatswain chair, needle beam and
 horizontal cable. While operating sprayguns, sandblasting,
 cobblasting and high pressure waterblasting (4000psi).

\$1.00 PER HOUR SHALL BE ADDED TO THE RATE OF PAY FOR THE
 CLASSIFICATION OF WORK:

For the application of catalized epoxy, including latex epoxy
 that is deemed hazardous, lead abatement, or for work or
 material where special precautions beyond normal work
 duties must be taken. For working on stacks, tanks, and
 towers over 40 feet in height.

 PAIN0813-005 12/01/2008

GALLIA, LAWRENCE, MEIGS & VINTON

	Rates	Fringes
PAINTER		
Base Rate.....	\$ 24.83	10.00
Bridges, Locks, Dams & Tension Towers.....	\$ 27.83	10.00

 PAIN0841-001 06/01/2018

MEDINA, PORTAGE (South of and including Ohio Turnpike), and
 SUMMIT (South of and including Ohio Turnpike) COUNTIES

	Rates	Fringes
Painters:		
GROUP 1.....	\$ 25.75	14.35
GROUP 2.....	\$ 26.40	14.35
GROUP 3.....	\$ 26.50	14.35
GROUP 4.....	\$ 26.60	14.35
GROUP 5.....	\$ 27.00	14.35
GROUP 6.....	\$ 39.20	11.75
GROUP 7.....	\$ 27.00	14.35

PAINTER CLASSIFICATIONS:

GROUP 1 - Brush, Roller & Paperhanger

GROUP 2 - Epoxy Application

GROUP 3 - Swing Scaffold, Bosum Chair, & Window Jack

GROUP 4 - Spray Gun Operator of Any & All Coatings

GROUP 5 - Sandblast, Painting of Standpipes, etc. from Scaffolds, Bridge Work and/or Open Structural Steel, Standpipes and/or Water Towers

GROUP 6 - Public & Commerce Transportation, Steel or Galvanized, Bridges, Tunnels & Related Support Items (concrete)

GROUP 7 - Synthetic Exterior, Drywall Finisher and/or Taper, Drywall Finisher and Follow-up Man Using Automatic Tools

PAIN0841-002 06/01/2018

CARROLL, COSHOCTON, HOLMES, STARK, TUSCARAWAS & WAYNE

	Rates	Fringes
PAINTER		
Bridges; Towers, Poles & Stacks; Sandblasting Steel; Structural Steel & Metalizing.....	\$ 22.78	13.63
Brush & Roller.....	\$ 21.77	13.63
Spray; Tank Interior & Exterior.....	\$ 22.60	13.63

PAIN1020-002 07/01/2020

ALLEN, AUGLAIZE, CHAMPAIGN, DEFIANCE, HARDIN, LOGAN, MERCER, PAULDING, PUTNAM, SHELBY, VAN WERT, and WILLIAMS COUNTIES

	Rates	Fringes
PAINTER		
Brush & Roller.....	\$ 25.22	14.11
Drywall Finishing & Taping..	\$ 23.92	14.11
Lead Abatement.....	\$ 26.97	14.11
Spray, Sandblasting Pressure Cleaning, & Refinery.....	\$ 25.87	14.11
Swing Stage, Chair, Spiders, & Cherry Pickers...	\$ 25.47	14.11
Wallcoverings.....	\$ 22.82	14.11

All surfaces 40 ft. or over where material is applied to or labor performed on, above ground level (exterior), floor level (interior) - \$.50 premium

Applying Coal Tar Products - \$1.00 premium

PAIN1275-002 06/01/2020

DELAWARE, FAIRFIELD, FAYETTE, FRANKLIN, MADISON, PICKAWAY, ROSS
& UNION

	Rates	Fringes
PAINTER		
Bridges.....	\$ 34.64	14.40
Brush; Roller.....	\$ 25.16	14.40
Sandblasting; Steamcleaning; Waterblasting (3500 PSI or Over) & Hazardous Work.....	\$ 25.86	14.40
Spray.....	\$ 25.66	14.40
Stacks; Tanks; & Towers.....	\$ 28.67	14.40
Structural Steel & Swing Stage.....	\$ 25.46	14.40

PLAS0109-001 05/01/2018

MEDINA, PORTAGE, STARK, and SUMMIT COUNTIES

	Rates	Fringes
PLASTERER.....	\$ 28.86	17.11

PLAS0109-003 05/01/2018

CARROLL, HOLMES, TUSCARAWAS, and WAYNE COUNTIES

	Rates	Fringes
PLASTERER.....	\$ 28.21	17.11

PLAS0132-002 05/01/2018

BROWN, BUTLER, CLERMONT, HAMILTON, HIGHLAND, WARREN COUNTIES

	Rates	Fringes
PLASTERER.....	\$ 28.86	17.11

PLAS0404-002 05/01/2018

ASHTABULA, CUYAHOGA, GEAUGA, AND LAKE COUNTIES

	Rates	Fringes
PLASTERER.....	\$ 29.63	17.11

PLAS0404-003 05/01/2018

LORAIN COUNTY

	Rates	Fringes
PLASTERER.....	\$ 28.86	17.11

PLAS0526-022 05/01/2018

COLUMBIANA, MAHONING, and TRUMBULL COUNTIES

	Rates	Fringes
PLASTERER.....	\$ 28.86	17.11

PLAS0526-023 05/01/2018

BELMONT, HARRISON, and JEFFERSON COUNTIES

	Rates	Fringes
PLASTERER.....	\$ 28.21	17.11

PLAS0886-001 05/01/2018

FULTON, HANCOCK, HENRY, LUCAS, PUTNAM, and WOOD COUNTIES

	Rates	Fringes
PLASTERER.....	\$ 29.63	17.11

PLAS0886-003 05/01/2018

DEFIANCE, ERIE, HURON, OTTAWA, PAULDING, SANDUSKY, and SENECA COUNTIES

	Rates	Fringes
PLASTERER.....	\$ 28.86	17.11

PLAS0886-004 05/01/2018

ALLEN, AUGLAIZE, HARDIN, LOGAN, MERCER, and VAN WERT COUNTIES

	Rates	Fringes
PLASTERER.....	\$ 28.21	17.11

PLUM0042-002 07/01/2018

ASHLAND, CRAWFORD, ERIE, HURON, KNOX, LORAIN, MORROW, RICHLAND & WYANDOT

	Rates	Fringes
Plumber, Pipefitter, Steamfitter.....	\$ 34.20	22.07

PLUM0050-002 07/06/2020

DEFIANCE, FULTON, HANCOCK, HENRY, LUCAS, OTTAWA, PAULDING, PUTNAM, SANDUSKY, SENECA, WILLIAMS & WOOD

	Rates	Fringes
Plumber, Pipefitter, Steamfitter.....	\$ 43.60	26.73

PLUM0055-003 05/04/2020

ASHTABULA, CUYAHOGA, GEAUGA, LAKE, MEDINA (N. of Rte. #18 & Smith Road) & SUMMIT (N. of Rte. #303, including the corporate limits of the city of Hudson)

	Rates	Fringes
PLUMBER.....	\$ 37.07	27.71

PLUM0083-001 07/01/2017

BELMONT & MONROE (North of Rte. #78)

	Rates	Fringes
Plumber and Steamfitter.....	\$ 32.16	31.51

PLUM0094-002 05/01/2020

CARROLL (Northen Half), STARK, and WAYNE COUNTIES

	Rates	Fringes
PLUMBER/PIPEFITTER.....	\$ 35.78	21.44

PLUM0120-002 05/04/2020

ASHTABULA, CUYAHOGA, GEAUGA, LAKE, LORAIN (the C.E.I. Power House in Avon Lake), MEDINA (N. of Rte. #18) & SUMMIT (N. of #303)

	Rates	Fringes
PIPEFITTER.....	\$ 40.22	25.48

PLUM0162-002 06/01/2020

CHAMPAIGN, CLARK, CLINTON, DARKE, FAYETTE, GREENE, MIAMI, MONTGOMERY & PREBLE

	Rates	Fringes
Plumber, Pipefitter, Steamfitter.....	\$ 32.25	26.47

PLUM0168-002 06/01/2019

MEIGS, MONROE (South of Rte. #78), MORGAN (South of Rte. #78) & WASHINGTON

	Rates	Fringes
PLUMBER/PIPEFITTER.....	\$ 35.32	31.63

PLUM0189-002 06/01/2019

DELAWARE, FAIRFIELD, FRANKLIN, HOCKING, LICKING, MADISON, MARION, PERRY, PICKAWAY, ROSS & UNION

	Rates	Fringes
Plumber, Pipefitter, Steamfitter.....	\$ 38.45	16.98

* PLUM0219-002 06/01/2020

MEDINA (Rte. #18 from eastern edge of Medina Co., west to eastern corporate limits of the city of Medina, & on the county road from the west corporate limits of Medina running due west to and through community of Risley to the western edge of Medina County - All territory south of this line), PORTAGE, and SUMMIT (S. of Rte. #303) COUNTIES

	Rates	Fringes
Plumber and Steamfitter.....	\$ 39.32	25.54

PLUM0392-002 06/01/2020

BROWN, BUTLER, CLERMONT, HAMILTON & WARREN

	Rates	Fringes
PLUMBER/PIPEFITTER.....	\$ 33.91	22.29

PLUM0396-001 08/01/2020

COLUMBIANA (Excluding Washington & Yellow Creek Townships & Liverpool Twp. - Secs. 35 & 36 - West of County Road #427), MAHONING and TRUMBULL COUNTIES

	Rates	Fringes
PLUMBER/PIPEFITTER.....	\$ 34.30	26.56

PLUM0495-002 06/01/2018

CARROLL (Rose, Monroe, Union, Lee, Orange, Perry & Loudon Townships), COLUMBIANA (Washington & Yellow Creek Townships & Liverpool Township, Secs. 35 & 36, West of County Rd. #427), COSHOCTON, GUERNSEY, HARRISON, HOLMES, JEFFERSON, MORGAN (South to State Rte. #78 & from McConnelsville west on State Rte. #37 to the Perry County line), MUSKINGUM, NOBLE, and TUSCARAWAS COUNTIES

	Rates	Fringes
Plumber, Pipefitter, Steamfitter.....	\$ 38.24	23.09

PLUM0577-002 06/01/2019

ADAMS, ATHENS, GALLIA, HIGHLAND, JACKSON, LAWRENCE, PIKE, SCIOTO & VINTON

Rates Fringes

Plumber, Pipefitter, Steamfitter.....	\$ 34.90	24.11
--	----------	-------

 PLUM0776-002 07/01/2020

ALLEN, AUGLAIZE, HARDIN, LOGAN, MERCER, SHELBY and VAN WERT
 COUNTIES

	Rates	Fringes
Plumber, Pipefitter, Steamfitter.....	\$ 37.63	25.58

 TEAM0377-003 05/01/2020

STATEWIDE, EXCEPT CUYAHOGA, GEAUGA & LAKE

	Rates	Fringes
TRUCK DRIVER		
GROUP 1.....	\$ 28.89	15.40
GROUP 2.....	\$ 29.31	15.40

TRUCK DRIVER CLASSIFICATIONS

GROUP 1 - Asphalt Distributor; Batch; 4- Wheel Service;
 4-Wheel Dump; Oil Distributor & Tandem

GROUP 2 - Tractor-Trailer Combination: Fuel; Pole Trailer;
 Ready Mix; Semi-Tractor; & Asphalt Oil Spraybar Man When
 Operated From Cab; 5 Axles & Over; Belly Dump; End Dump;
 Articulated Dump; Heavy Duty Equipment; Low Boy; & Truck
 Mechanic

 TEAM0436-002 05/01/2020

CUYAHOGA, GEAUGA & LAKE

	Rates	Fringes
TRUCK DRIVER		
GROUP 1.....	\$ 29.55	16.95
GROUP 2.....	\$ 30.05	16.95

GROUP 1: Straight & Dump, Straight Fuel

GROUP 2: Semi Fuel, Semi Tractor, Euclids, Darts, Tank,
 Asphalt Spreaders, Low Boys, Carry-All, Tourna-Rockers,
 Hi-Lifts, Extra Long Trailers, Semi-Pole Trailers, Double
 Hook-Up Tractor Trailers including Team Track & Railroad
 Siding, Semi-Tractor & Tri-Axle Trailer, Tandem Tractor &
 Tandem Trailer, Tag Along Trailer, Expandable Trailer or
 Towing Requiring Road Permits, Ready-Mix (Agitator or
 Non-Agitator), Bulk Concrete Driver, Dry Batch Truck,
 Articulated End Dump

 WELDERS - Receive rate prescribed for craft performing

operation to which welding is incidental.

=====
Note: Executive Order (EO) 13706, Establishing Paid Sick Leave for Federal Contractors applies to all contracts subject to the Davis-Bacon Act for which the contract is awarded (and any solicitation was issued) on or after January 1, 2017. If this contract is covered by the EO, the contractor must provide employees with 1 hour of paid sick leave for every 30 hours they work, up to 56 hours of paid sick leave each year. Employees must be permitted to use paid sick leave for their own illness, injury or other health-related needs, including preventive care; to assist a family member (or person who is like family to the employee) who is ill, injured, or has other health-related needs, including preventive care; or for reasons resulting from, or to assist a family member (or person who is like family to the employee) who is a victim of, domestic violence, sexual assault, or stalking. Additional information on contractor requirements and worker protections under the EO is available at www.dol.gov/whd/govcontracts.

Unlisted classifications needed for work not included within the scope of the classifications listed may be added after award only as provided in the labor standards contract clauses (29CFR 5.5 (a) (1) (ii)).

The body of each wage determination lists the classification and wage rates that have been found to be prevailing for the cited type(s) of construction in the area covered by the wage determination. The classifications are listed in alphabetical order of ""identifiers"" that indicate whether the particular rate is a union rate (current union negotiated rate for local), a survey rate (weighted average rate) or a union average rate (weighted union average rate).

Union Rate Identifiers

A four letter classification abbreviation identifier enclosed in dotted lines beginning with characters other than ""SU"" or ""UAVG"" denotes that the union classification and rate were prevailing for that classification in the survey. Example: PLUM0198-005 07/01/2014. PLUM is an abbreviation identifier of the union which prevailed in the survey for this classification, which in this example would be Plumbers. 0198 indicates the local union number or district council number where applicable, i.e., Plumbers Local 0198. The next number, 005 in the example, is an internal number used in processing the wage determination. 07/01/2014 is the effective date of the most current negotiated rate, which in this example is July 1, 2014.

Union prevailing wage rates are updated to reflect all rate changes in the collective bargaining agreement (CBA) governing this classification and rate.

Survey Rate Identifiers

Classifications listed under the ""SU"" identifier indicate that no one rate prevailed for this classification in the survey and the published rate is derived by computing a weighted average rate based on all the rates reported in the survey for that classification. As this weighted average rate includes all rates reported in the survey, it may include both union and non-union rates. Example: SULA2012-007 5/13/2014. SU indicates the rates are survey rates based on a weighted average calculation of rates and are not majority rates. LA indicates the State of Louisiana. 2012 is the year of survey on which these classifications and rates are based. The next number, 007 in the example, is an internal number used in producing the wage determination. 5/13/2014 indicates the survey completion date for the classifications and rates under that identifier.

Survey wage rates are not updated and remain in effect until a new survey is conducted.

Union Average Rate Identifiers

Classification(s) listed under the UAVG identifier indicate that no single majority rate prevailed for those classifications; however, 100% of the data reported for the classifications was union data. EXAMPLE: UAVG-OH-0010 08/29/2014. UAVG indicates that the rate is a weighted union average rate. OH indicates the state. The next number, 0010 in the example, is an internal number used in producing the wage determination. 08/29/2014 indicates the survey completion date for the classifications and rates under that identifier.

A UAVG rate will be updated once a year, usually in January of each year, to reflect a weighted average of the current negotiated/CBA rate of the union locals from which the rate is based.

WAGE DETERMINATION APPEALS PROCESS

1.) Has there been an initial decision in the matter? This can be:

- * an existing published wage determination
- * a survey underlying a wage determination
- * a Wage and Hour Division letter setting forth a position on a wage determination matter
- * a conformance (additional classification and rate) ruling

On survey related matters, initial contact, including requests for summaries of surveys, should be with the Wage and Hour Regional Office for the area in which the survey was conducted because those Regional Offices have responsibility for the Davis-Bacon survey program. If the response from this initial contact is not satisfactory, then the process described in 2.) and 3.) should be followed.

With regard to any other matter not yet ripe for the formal process described here, initial contact should be with the Branch of Construction Wage Determinations. Write to:

Branch of Construction Wage Determinations
Wage and Hour Division
U.S. Department of Labor
200 Constitution Avenue, N.W.
Washington, DC 20210

2.) If the answer to the question in 1.) is yes, then an interested party (those affected by the action) can request review and reconsideration from the Wage and Hour Administrator (See 29 CFR Part 1.8 and 29 CFR Part 7). Write to:

Wage and Hour Administrator
U.S. Department of Labor
200 Constitution Avenue, N.W.
Washington, DC 20210

The request should be accompanied by a full statement of the interested party's position and by any information (wage payment data, project description, area practice material, etc.) that the requestor considers relevant to the issue.

3.) If the decision of the Administrator is not favorable, an interested party may appeal directly to the Administrative Review Board (formerly the Wage Appeals Board). Write to:

Administrative Review Board
U.S. Department of Labor
200 Constitution Avenue, N.W.
Washington, DC 20210

4.) All decisions by the Administrative Review Board are final.

=====

END OF GENERAL DECISION"

ADVERTISEMENT FOR BIDS

Sealed bids will be received by the Clerk of the County Commissioners, Warren County, Ohio, 406 Justice Drive, Lebanon, Ohio 45036, until 9:30 a.m., June 1, 2021 and then at said time bids will be opened and read aloud for the FY20 South Lebanon / Union Township – Lebanon Road Improvement CDBG Project for the Warren County Office of Grants Administration.

Bid packets may be obtained through our website: www.co.warren.oh.us/Commissioners/Bids
Each bid shall contain the full name of each person or company submitting the bid and be accompanied by a bid bond for the full amount of the bid or a certified check in the amount equal to ten (10) percent of the bid.

All contractors and sub-contractors involved with this project will, to the extent practicable, use Ohio products, materials, services, and labor in the implementation of this project. Additionally, contractor compliance with the Equal Opportunity Requirements of the Ohio Administrative Code Chapter 123, the Governor's Executive Order of 1972 and Governor's Executive Order 84-9 shall be required.

Bidders must comply with the Davis-Bacon Act for prevailing wage requirements for Federally funded projects.

This notice is posted on the Warren County website: www.co.warren.oh.us/Commissioners/Bids. Please contact the Warren County Commissioners' Office at (513) 695-1250 if you have trouble with this procedure or if you need additional information on accessing bid project information on our website.

Please be aware that if you are downloading this document to bid this project, addendums to the scope may be issued prior to the bid date. In order to stay updated on any change, please email Susanne Mason at in the Grants Administration at susanne.mason@co.warren.oh.us with your contact information.

The Board of Warren County Commissioners reserves the right to accept the lowest and best bid, to reject all bids, and to waive any irregularities in bids. To be placed on the Plan Holders List and notified of any addendums, you must email Susanne.Mason@co.warren.oh.us with your contact information.

By order of the Board of County Commissioners, Warren County, Ohio.

* * * * *

Journal News Pulse of Lebanon and Mason:

Please publish the above advertisement one (1) time, the week of May 16, 2021.

Bill to Warren County Commissioners